

## Series 375

# Granville-Phillips® Series 375 Convectron® Vacuum Gauge Controller



## Instruction Manual

*Instruction manual part number 375015*

*Revision 05 - April 2008*



## Series 375

# Granville-Phillips® Series 375 Convectron® Vacuum Gauge Controller

This Instruction Manual is for use with all Granville-Phillips Series 375 Convectron Vacuum Gauge Controllers. A list of applicable catalog numbers is provided on the following page.



### ***Customer Service/Support***

For customer service, 24 hours per day, 7 days per week, every day of the year including holidays, toll-free within USA, phone 1-800-367-4887

For customer service within USA, 8 AM to 5 PM weekdays excluding holidays:

- Toll-free, phone: 1-800-776-6543
- Phone: 1-303-652-4400
- FAX: 1-303-652-2844
- Email: [co-csr@brooks.com](mailto:co-csr@brooks.com)
- World Wide Web: [www.brooks.com](http://www.brooks.com)

## Instruction Manual

# Granville-Phillips® Series 375 Convectron® Vacuum Gauge Controller

## Catalog numbers for Series 375 Convectron Vacuum Gauge Controllers

### 1/8 DIN, panel mount with digital display

Operating Power: 12 to 24 Vdc

This Instruction Manual is for use with the following catalog numbers.  
The “#” symbol represents a variable in the catalog number. The variables are listed below.

375001-#	375001-##-#	(20)375017	(20)375020	(20)375022
(20)375027	(20)375029-#	(20)375025-##-#	375002	375003
375004	375005	375006	375007	375009
375010	375011	375012	375030	375036
375037	375041	375029-#	375012-#	375043

## Variables in the catalog numbers for Series 375 Convectron Vacuum Gauge Controllers

375001 - # # - #

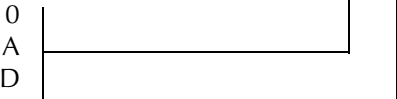
### InterfaceOptions (Slot X)

- None
- RS-232
- RS-485/422



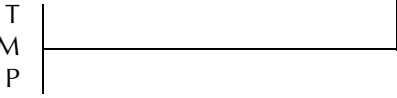
### Setpoint option (Slot Y):

- None
- 2 setpoint relays
- 4 setpoint relays



### Measurement Units::

- Torr
- mbar
- pascal



### Option Cards - for field installation::

RS-232	375002
RS-485/422	375003
2 setpoint relays	375005

# Table of Contents

<b>Safety</b> .....	7
Safety Instructions .....	7
Damage Requiring Service .....	8
Proper Grounding .....	8
Overpressure Conditions .....	9
Certification .....	10
Extended Warranty .....	10
Service Guidelines .....	10
<b>Chapter 1 Series 375 System Components</b> .....	11
1.1 Components and Options .....	11
<b>Chapter 2 Initial Setup Procedures</b> .....	13
2.1 Pre-Installation Considerations .....	13
2.2 Mounting Convectron Gauges .....	13
Important Notes: 14	
2.2.1 Compression Mount/Quick Connect .....	14
2.2.2 1/8 NPT Mount .....	15
2.2.3 VCR/VCO Mount .....	15
2.2.4 NW16KF Flange Mount .....	15
2.2.5 ConFlat Flange Mount .....	15
2.3 Controller Installation .....	15
2.4 Connecting the Cables .....	16
2.4.1 Power Supply .....	16
<b>Chapter 3 Preparing the Convectron Gauge for Operation</b> .....	19
3.1 Preparing for Pressure Measurement .....	19
3.2 Convectron Gauge Controller Factory Default Settings .....	19
3.3 Controller Front Panel .....	19
3.3.1 Switch Overview .....	20
3.3.2 Lock Switch .....	20
3.4 Gas Type .....	20
3.5 Preparing For Convectron Gauge Operation .....	20
3.6 Understanding Convectron Gauge Pressure Measurement In Gases Other Than Nitrogen (or Air) .....	21
3.6.1 Examples .....	23
3.7 Adjustment of Convectron Gauge Zero and Atmospheric Pressure Indications .....	30
3.7.1 Special Considerations for Convectron Gauge Use Below $10^{-3}$ Torr .....	31
3.7.2 375 NIST Traceable System Calibration .....	31
3.7.2.1 375 Controller Function after System Calibration .....	31
3.7.2.2 Voiding the System Calibration .....	31
3.8 Convectron Gauge Analog Output Signal .....	32
3.8.1 Optional Analog Output of 1 – 8 V .....	32
3.8.2 Optional Nonlinear Analog Output “S Curve” .....	33
<b>Chapter 4 Process Control</b> .....	35
4.1 Process Control Factory Default Settings .....	35
4.2 Process Control Setup .....	35
4.3 Connecting Process Control Relays .....	36
4.4 Setpoint Display and Adjustment .....	37
4.5 Process Control Tips .....	37

4.6	4-Channel Process Control	38
4.6.1	Process Control Factory Default Settings	38
4.6.2	Relay Contact Ratings	38
4.6.3	Computer Interface Commands	38
<b>Chapter 5</b>	<b>RS-232 Computer Interface</b>	<b>39</b>
5.1	RS-232 Computer Interface Setup	39
5.2	RS-232 Computer Interface Factory Default Settings	39
5.3	RS-232 Computer Interface Settings	39
5.3.1	Baud Rate	39
5.3.2	Selecting the Byte Format	40
5.3.3	Handshaking	40
5.3.4	Enabling the RTS/CTS Connection	40
5.4	Connecting the RS-232 Computer Interface	42
5.4.1	9-Pin RS-232 Interconnection to Computer	43
5.5	Preparing for Use of the RS-232 Computer Interface	44
5.6	RS-232 Command Syntax	45
5.6.1	Command Descriptions	45
5.7	Command-Response Timing	49
<b>Chapter 6</b>	<b>RS-485/422 Computer Interface</b>	<b>51</b>
6.1	RS-485/422 Computer Interface Setup	51
6.2	RS-485/422 Computer Interface Factory Default Settings	51
6.3	RS-485/422 Computer Interface Settings	51
6.3.1	Baud Rate	51
6.3.2	Selecting the Byte Format	52
6.3.3	Selecting an Address	52
6.3.4	Selecting RS-485, RS-422 2- or 4-Wire Operation	52
6.3.5	Handshaking	54
6.3.5.1	Line Termination	55
6.3.5.2	Communications Protocol	55
6.4	Connecting the RS-485/422 Computer Interface	55
6.4.1	Long Cable Operation	56
6.5	Preparing for Use of the RS-485/422 Computer Interface	56
6.6	RS-485/422 Command Syntax	57
6.6.1	Command Descriptions	57
6.7	Command-Response Timing	62
<b>Chapter 7</b>	<b>Service and Maintenance</b>	<b>63</b>
7.1	Service Guidelines	63
7.2	Damage Requiring Service	64
7.3	Symptoms and Possible Causes	65
7.4	Convectron Gauge Test Procedure	65
7.5	Cleaning Contaminated Convectron Gauges	65
7.6	Process Control Troubleshooting	66
7.7	RS-232 Troubleshooting	66
7.8	RS-485/422 Troubleshooting	67
7.8.1	Field Installation of Options	68
7.9	Factory Default Settings	68

## Safety Instructions

**START BY READING THESE IMPORTANT SAFETY INSTRUCTIONS AND NOTES** collected here for your convenience and repeated with additional information at appropriate points in these instructions.



**This warning symbol indicates a hazardous or unsafe condition that could lead to personal injury or death from electrical shock.**



**Note statements indicate conditions that could lead to improper equipment performance, but will not lead to unsafe conditions.**

In these instructions the word “product” refers to the 375 Convectron Gauge Controller and all of its approved parts and accessories.

*NOTE: These instructions do not and cannot provide for every contingency that may arise in connection with the installation, operation, or maintenance of this product. If you require further assistance, contact Brooks Automation, Inc./Granville-Phillips at the address on the title page of this manual.*

***This product provides reasonably safe service when it is installed, operated, and serviced in strict accordance with these safety instructions.***

These safety precautions must be observed during all phases of operation, installation, and service of this product. Failure to comply with these precautions or with specific warnings elsewhere in this manual violates safety standards of design, manufacture, and intended use of the instrument. Helix Technology disclaims all liability for the customer's failure to comply with these requirements.



**The service and repair information in this manual is for the use of Qualified Service Personnel. To avoid shock, do not perform any procedures in this manual or perform any servicing on this product unless you are qualified to do so.**

- *Read Instructions* – Read all safety and operating instructions before operating the product.
- *Retain Instructions* – Retain the Safety and Operating Instructions for future reference.
- *Heed Warnings* – Adhere to all warnings on the product and in the operating instructions.
- *Follow Instructions* – Follow all operating and maintenance instructions.
- *Accessories* – *Do not* use accessories not recommended in this manual as they may be hazardous.



**To reduce the risk of fire or electric shock, do not expose this product to rain or moisture.**



**Do not modify this instrument.**

**Return the product to a service facility designated by Brooks Automation, Inc. / Granville-Phillips for service and repair to ensure that safety features are maintained. Do not use this product if it has unauthorized modifications.**

## Damage Requiring Service

Disconnect the product from the wall outlet and all power sources and refer servicing to Qualified Service Personnel under the following conditions:

- a. When any cable or plug is damaged.
- b. If the product has been exposed to rain or water.
- c. If the product does not operate normally even if you follow the operating instructions. Adjust only those controls that are covered by the operation instructions. Improper adjustment of other controls may result in damage and will often require extensive work by a qualified technician to restore the product to its normal operation.
- d. If the product has been dropped or the enclosure has been damaged.
- e. When the product exhibits a distinct change in performance. This indicates a need for service.

## Proper Grounding



**All conductors in, on, or around the vacuum system that are exposed to potential high voltage electrical discharges must either be shielded at all times to protect personnel or must be connected to earth ground at all times.**



**Replacement Parts - When replacement parts are required, be certain to use the replacement parts that are specified by Brooks Automation Inc. / Granville-Phillips, or that have the same characteristics as the original parts. Unauthorized substitutions may result in fire, electric shock or other hazards.**



**Safety Check - Upon completion of any service or repairs to this product, ask the Qualified Service Person to perform safety checks to determine that the product is in safe operating order.**



**Finite Lifetime - After ten years of normal use or even non-use, the electrical insulation in this product may become less effective at preventing electrical shock. Under certain environmental conditions which are beyond the manufacturer's control, some insulation material may deteriorate sooner. Therefore, periodically inspect all electrical insulation for cracks, crazing, or other signs of deterioration. Do not use if the electrical insulation has become unsafe.**



**Be aware that an electrical discharge through a gas may couple dangerous high voltage directly to an ungrounded conductor almost as effectively as would a copper wire connection. A person may be seriously injured or even killed by merely touching an exposed ungrounded conductor at high potential. This hazard is not unique to this product.**



**Install suitable devices that will limit the pressure to the level that the vacuum system can safely withstand. In addition, install suitable pressure relief valves or rupture disks that will release pressure at a level considerably below the pressure that the system can safely withstand.**



## Overpressure Conditions

Confirm that these safety devices are properly installed before installing the product. In addition, check that (1) the proper gas cylinders are installed, (2) gas cylinder valve positions are correct on manual systems, and (3) the automation is correct on automated gas delivery systems.

Vacuum gauges with compression fittings may be forcefully ejected if the vacuum system is pressurized.

Suppliers of pressure relief valves and pressure relief disks are listed in the *Thomas Register* under "Valves, Relief", and "Discs, Rupture".



**Install suitable devices that will limit the pressure to the level that the vacuum system can safely withstand. In addition, install suitable pressure relief valves or rupture disks that will release pressure at a level considerably below the pressure that the system can safely withstand.**



**All components of a vacuum system used with this or any similar high voltage product must be maintained at earth ground for safe operation. The power cord of this product shall be connected only to a properly grounded outlet. Be aware, however, that grounding this product does not guarantee that other components of the vacuum system are maintained at earth ground.**

**Complying with the usual warning to connect the power cable only to a properly grounded outlet is necessary but not sufficient for safe operation of a vacuum system with this or any similar high voltage producing product.**

**Verify that the vacuum port to which the Convectron Gauge is mounted is electrically grounded. It is essential for personnel safety as well as proper operation that the envelope of the gauge be connected to a facility ground. Use a ground lug on a flange bolt if necessary.**



**Using the N<sub>2</sub> calibration to pressurize a vacuum system above about 1 Torr with certain other gases can cause dangerously high pressures which may cause explosion of the system. See Section 3.6 before using with other gases.**



**Warning - If used improperly, Convectron Gauges can supply misleading pressure indications that can result in dangerous overpressure conditions within the system. For use with gases other than air or N<sub>2</sub>, consult the gas type correction charts in Section 3.6.**



**Do not operate in an explosive atmosphere.**

**Do not operate the product in the presence of flammable gases or fumes. Operation of any electrical instrument in such an environment constitutes a definite safety hazard.**

**Do not use the product to measure the pressure of explosive or combustible gases or gas mixtures. The sensor wire of the Convectron Gauge normally operates at only 125 °C, but it is possible that Controller malfunction can raise the sensor temperature above the ignition temperature of combustible mixtures.**

**Danger of explosion or inadvertent venting to atmosphere exists on all vacuum systems which incorporate gas sources or involve processes capable of pressurizing the system above safe limits.**



**The fumes from solvents such as trichloroethylene, perchloroethylene, toluene, and acetone can be dangerous to health if inhaled. Use only in well ventilated areas exhausted to the outdoors. Acetone and toluene are highly flammable and should not be used near an open flame or energized electrical equipment.**

## Certification

Brooks Automation, Inc. certifies that this product met its published specifications at the time of shipment from the factory. Brooks Automation further certifies that its calibration measurements are traceable to the National Institute of Standards and Technology to the extent allowed by the Institute's calibration facility. See the CE Declaration of Conformity inside envelope for the CE tests performed.

## Extended Warranty

Brooks Automation, Inc. provides an extended warranty period to five (5) years from the date of shipment for the Granville-Phillips Series 375 Controllers. The Brooks Automation, Inc. General Terms and Conditions of Sale provides the complete and exclusive warranty for Brooks Automation, Inc. products. This document is located on our web site at [www.brooks.com](http://www.brooks.com), or may be obtained by contacting a Brooks Automation Customer Service Representative.

## Service Guidelines

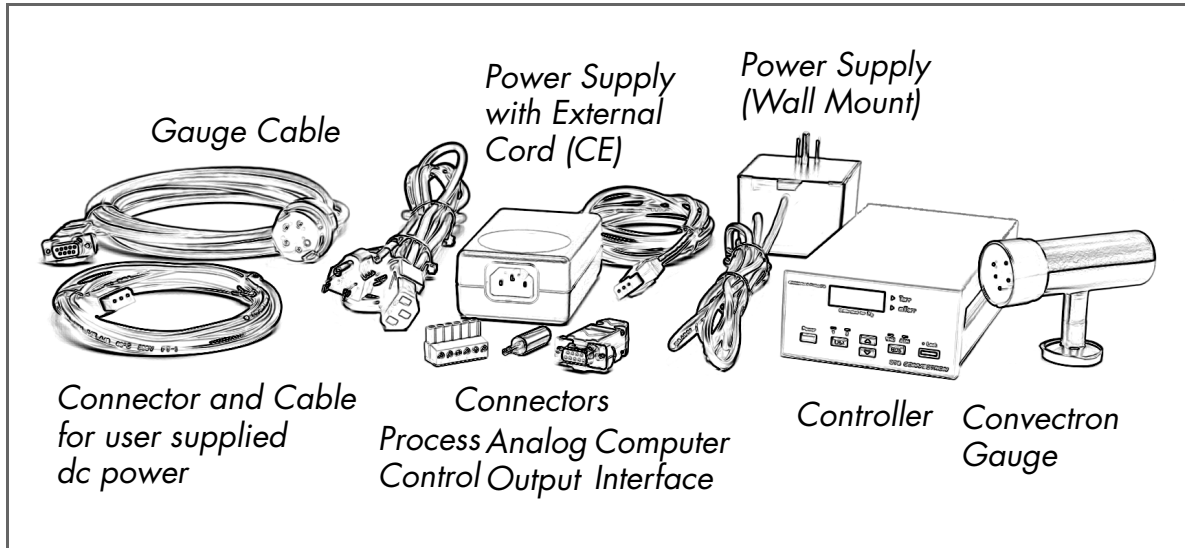
Some minor problems are readily corrected on site. If the product requires service, contact our Customer Service Department at 1-800-776-6543 for troubleshooting help over the phone. Other phone numbers are published at the front of this manual. For Global Customer Support, go to [www.brooks.com](http://www.brooks.com), click on Contact Us, then click on Global Offices to locate the Brooks Automation office nearest you.

If the product must be returned for service, request a Return Authorization (RA) from Brooks Automation / Granville-Phillips. Do not return products without first obtaining an RA. In some cases a hazardous materials document may be required. The Brooks Automation / Granville-Phillips Customer Service Representative will advise you if the hazardous materials document is required.

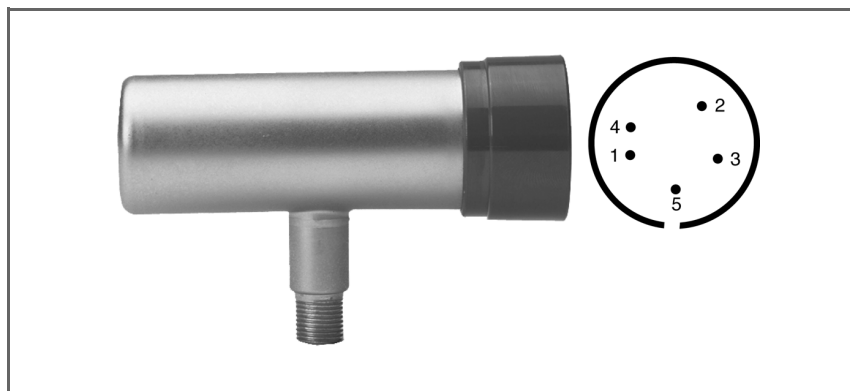
When returning equipment to Brooks Automation / Granville-Phillips, be sure to package the products to prevent shipping damage. Circuit boards and modules separated from the controller chassis must be handled using proper anti-static protection methods and must be packaged in anti-static packaging. Brooks Automation / Granville-Phillips will supply return packaging materials at no charge upon request. Shipping damage on returned products as a result of inadequate packaging is the Buyer's responsibility.

### 1.1 Components and Options

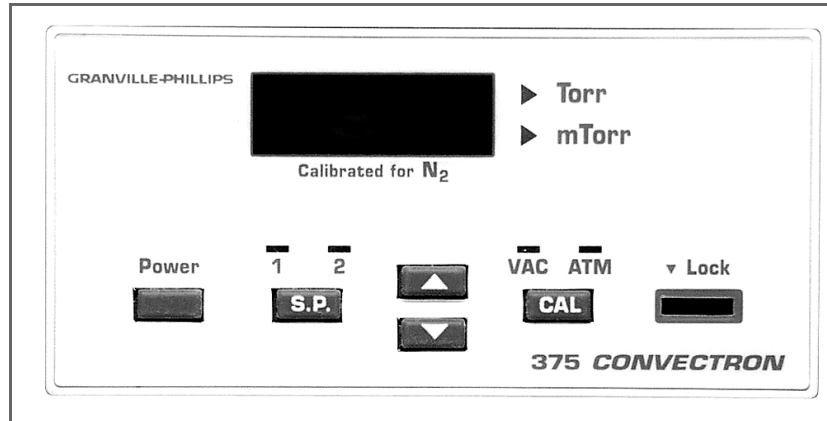
For completeness, some of the figures in this chapter include all available options and system capabilities including: Process Control, and RS-232 or RS-422/485 Computer Interface Modules.



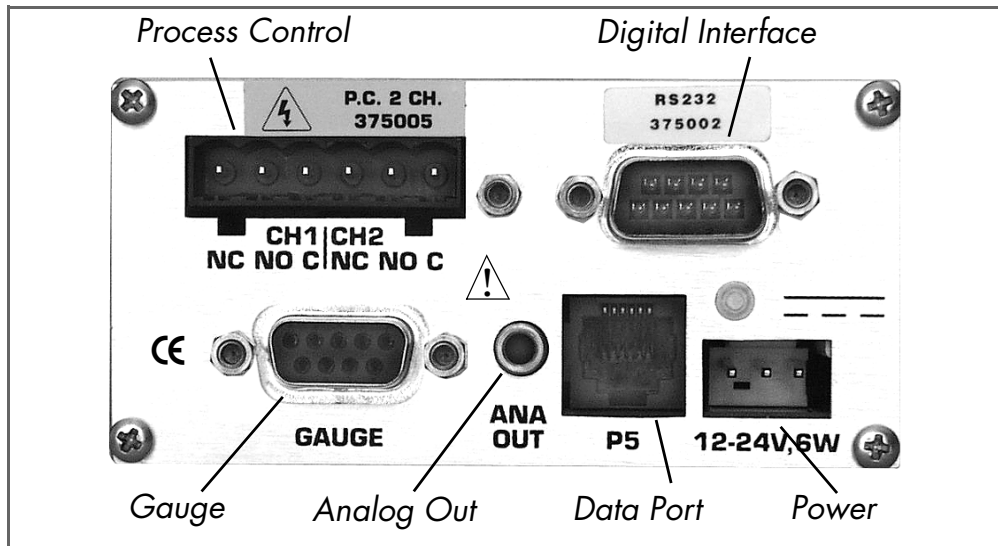
**Figure 1-1** Convectron Vacuum Measurement System.



**Figure 1-2** Convectron Gauge (side and end views.)



**Figure 1-3** Convectron Controller Front Panel.



**Figure 1-4** Convectron Controller Rear Panel Showing Connections.

## 2.1 Pre-Installation Considerations

The purpose of this chapter is to guide you through the basic setup procedures for the Series 375 Convectron Vacuum Measuring System. You will find information on mounting Convectron gauges, connecting gauge cables, connecting analog output cables, and mounting the Controller.

**Table 2-1** Factory Defaults for Options.

Option	Factory Default Settings
Process Control	Pressure Set Point Polarity (-): Relay pulls in below Setpoint. (0.0)
RS-232 Computer Interface	19.2 kbaud, 8 data bits, no parity, 1 stop bit; RTS/CTS disabled
RS-422/485 Computer Interface	19.2 kbaud, 8 data bits, no parity, 1 stop bit; address = 01; RS-422/485 4-wire operation (Separate RX/TX lines)

*NOTE: If options in your application require different settings than the factory defaults listed above, see the individual chapters for each option for instructions on changing the settings. You can reconfigure options either before or after completing the basic setup procedures in this chapter.*

## 2.2 Mounting Convectron Gauges

Where you mount the gauges is critical to obtaining reliable pressure measurements. Long tubing or other constrictions can cause large errors in pressure readings. If you mount the gauge near the pump, the pressure in the gauge may be considerably lower than in the rest of the system. If you place the gauge near a gas inlet or other source of contamination, the pressure in the gauge may be much higher than in the rest of the system.

If the gauge tube will be used to measure pressures greater than 1 Torr, the tube must be mounted with its axis horizontal. Although the gauge tube will read correctly below 1 Torr when mounted in any position, erroneous readings will result at pressures above 1 Torr if the tube axis is not horizontal.

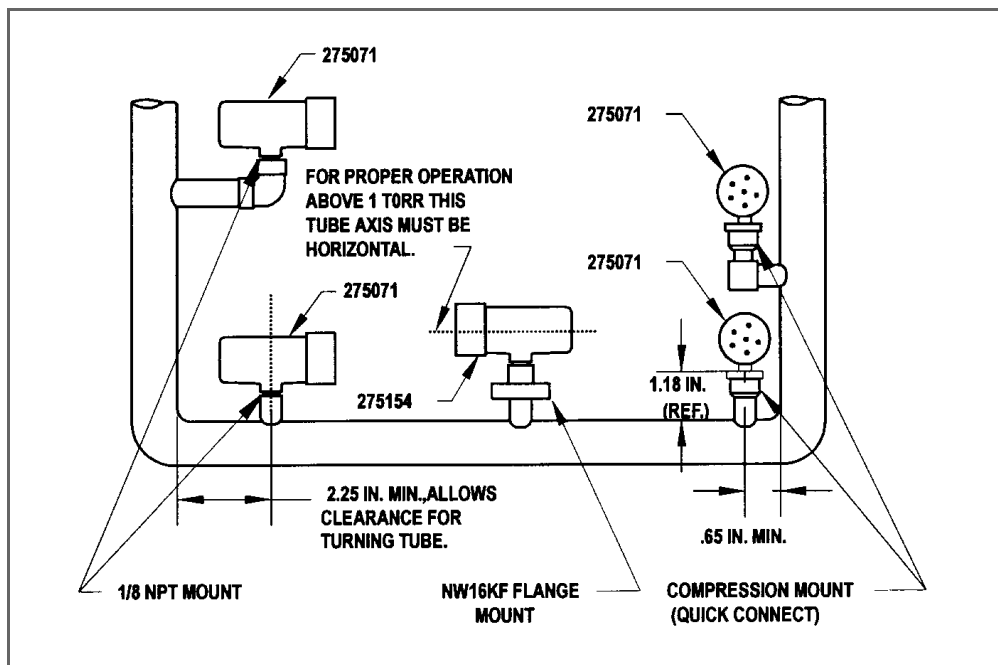
To minimize temperature effects, locate pressure gauges away from internal and external heat sources, in an area where the ambient temperature is reasonably constant.



**When high voltage is present, all exposed conductors of a vacuum must be maintained at earth ground.**

Under certain conditions, dangerously high voltage can be conducted through a gas directly to an ungrounded conductor almost as effectively as through a copper wire. The ability of an electric current to flow through a gas under certain circumstances poses a serious risk. Do not touch the exposed pins on any gauge installed on a vacuum system when high voltage is present.

The Convector Gauge envelope may not be reliably grounded through its vacuum connection. For safety, you must either add a separate ground wire or shield the envelope to prevent human contact. Ground the gauge envelope by using a metal hose clamp on the gauge connected by a #12 AWG (minimum size) copper wire to the grounded vacuum chamber.



**Figure 2-1** Convector Gauge Installation.

### Important Notes:

- Cleanliness pays. Keep the port cover in place until moments before installation.
- For proper operation above about 1 Torr, install Convector Gauges with the gauge axis horizontal.
- Vibration causes convection cooling of the sensor and will result in high pressure readings. Mount Convector Gauges where they will not vibrate excessively.
- Orient the gauge to prevent condensation of process vapors on the internal surfaces through line-of-sight access to its interior. If vapor condensation is likely, orient the port downward to help liquids drain out.

### 2.2.1 Compression Mount/Quick Connect

Do not use for positive pressure applications: The gauge may be forcefully ejected. The gauge port is designed to fit a standard 1/2 in. compression/quick connect mounting such as an Ultra-Torr<sup>®1</sup> fitting.

### 2.2.2 1/8 NPT Mount

Fits standard 1/8 NPT female fitting. Wrap the threads of the gauge port with TEFLON<sup>®2</sup> tape and hand tighten. Do not use a wrench or tool. Tighten only enough to achieve a seal.

### 2.2.3 VCR/VCO Mount

Remove the plastic or metal bead protector cap from the bead. When using a gasket, place it into the female nut where applicable. Assemble the components and snug finger-tight. While holding a back-up wrench stationary, tighten the female nut 1/8 turn past finger-tight for 316 stainless steel and nickel gaskets; or 1/4 turn past finger-tight for copper and aluminum gaskets.

### 2.2.4 NW16KF Flange Mount

The KF mounting system requires O-rings and centering rings between mating flanges. Tightening the wing nut will hold the flanges and the aluminum flange clamp together. Maximum pressure for this style of mounting system is 1000 Torr absolute.

### 2.2.5 ConFlat Flange Mount

1. To minimize the possibility of leaks with ConFlat<sup>3</sup> flanges, use high strength stainless steel bolts and a new, clean OFHC copper gasket. Avoid scratching the seal surfaces. To avoid contamination, do not use nonmetal gaskets.
2. Finger tighten all bolts. Use a wrench to continue tightening 1/8 turn at a time in crisscross order, e.g., 1, 4, 2, 5, 3, 6, 4 until all flanges are in contact. After contact, further tighten each bolt about 1/16 turn.

## 2.3 Controller Installation

Reconfigure system options before you mount the Control Unit. See Chapter 3 for details.

Provide adequate ventilation for the Controller to dissipate 6 watts.

Do not mount the Controller above other equipment that generates excessive heat.

This product is designed to operate within the range 0-40 °C. Ambient temperatures above 40 °C may damage the product.

The Controller may be used free-standing or panel mounted. When mounting the Controller in a panel follow these steps:

1. The required panel opening dimensions are 9.2 cm x 4.5 cm (3.6 in. x 1.77 in.) Panel thicknesses of between 3 mm to 1/8 in. are acceptable. Provide a minimum of 6.4 cm (2.5 in.) clearance behind the Controller to allow for connecting cables.
2. Remove the plastic bezel from the front of the Controller by prying off with a small screwdriver in slots at the ends of the bezel.

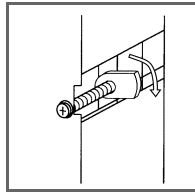
---

1. . Ultra-Torr, VCR, and VCO are registered trademarks of Cajon Co.

2. . TEFLON is a registered trademark of DuPont.

3. . ConFlat is a registered trademark of Varian Associates

3. Insert the Controller into the panel opening and turn the pawl screw on each side of the front panel to engage and secure the Controller to the panel. See Figure 2-2. Do not overtighten.

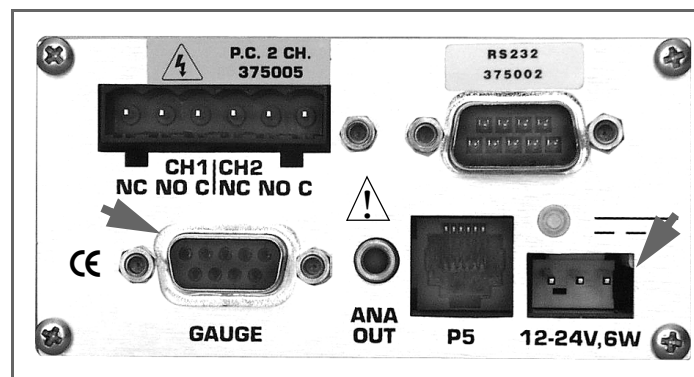


**Figure 2-2** Pawl Screw Used to Attach Controller to Panel.

4. Replace the plastic bezel by aligning on one side and pushing the other side on the Controller.

## 2.4 Connecting the Cables

1. Never touch the connector pins on any vacuum gauge if high voltages are present in the vacuum system. An electrical discharge or plasma may couple high voltage to the pins.
2. Connect the Convectron Gauge cable between the Controller and gauge. See Figure 2-3.



**Figure 2-3** Rear Panel of Control Unit Showing Convectron Gauge Cable and Power Connections.

3. Connect power by inserting the power cord with the locking tab up. See Section 2.4.1.
4. **Before you turn on and operate the system**, complete all relevant steps in this chapter to complete the basic system setup.

*NOTE: If you are using the Process Control option, you must prepare for process control operation before turning on the Series 375 System. See Chapter 4 for complete process control setup instructions. Attempting automatic operation with process control before the controls are properly set can be dangerous and can cause costly damage to the system.*

### 2.4.1 Power Supply

Three options exist to supply power to Series 375 Controllers:

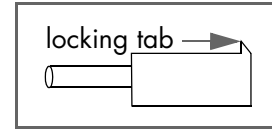
1. Wall Mount, 115 Vac, 60 Hz Input, 24 Vdc Output, 3-prong (Cat. No. 375006)
2. Bench Mount, 90 Vac – 250 Vac Input, 24 Vdc Output, connection plugs to work with local AC plug type. (Cat. No. 375007-1 – 6) (For use in CE compliant systems.)



**3.** Wire adapter to connect to user supplied 12 to 24 Vdc supply voltage.

(G-P Part No. 013482)

All three of the power supply options connect to the Controller with the same orientation and connection plug. The locking tab mechanism is on the top side of the connector when plugging it into the rear panel.



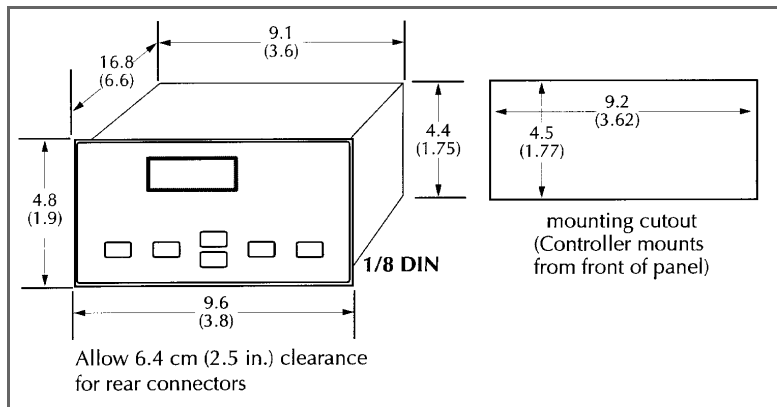
**Figure 2-4** Locking Tab.

When using the wire adapter (option number 3 above) the wires to be connected to the user supplied power are marked on the end of the cable:

- Outside:** Supply ground for 12 to 24 Vdc supply
- Center:** +12 to +24 Vdc power < 0.5 A @ 12 V (i.e. < 6 watts)
- Colored End:** Safety chassis ground.

*NOTE: The power supply is internally limited to 30 V maximum and 0.5 A. Do not connect input to high voltage.*

	<b>All conductors in, on, or around the vacuum system that are exposed to potential high voltage electrical discharges must either be shielded at all times to protect personnel or must be connected to earth ground.</b>
	<b>Compliance with the usual warning to connect the power cable only to a properly grounded outlet is necessary but not sufficient for safe operation of a vacuum system with this or any similar high voltage producing product. Grounding this product does not and cannot guarantee that other components of the vacuum system are all maintained at earth ground.</b>
	<b>It is the installer's responsibility to ensure that the automatic signals provided by the product are always used in a safe manner. Carefully check the system programming before switching to automatic operation.</b>
	<b>Where an equipment malfunction could cause a hazardous situation, always provide for fail-safe operation. As an example, in an automatic backfill operation where a malfunction might cause high internal pressures, provide an appropriate pressure relief device.</b>



**Figure 2-5** Controller Standard Mounting Dimensions.

## NOTES

### 3.1 Preparing for Pressure Measurement

The steps in this chapter assume:

- Your Series 375 Convectron System was properly set up and installed per the instructions in Chapter 2.
- The gas in your vacuum system is air, N<sub>2</sub>. If you are using other gases you must follow the instructions in Section 3.6.
- You are reasonably familiar with the general theory of operation of thermal conductivity gauges.

It is recommended that you consult a good textbook if you are unfamiliar with vacuum technology or if you require more information on the general theory behind operating a thermal conductivity gauge. The following books are useful reference volumes.

- Dushman, S., Lafferty, J. M., *Scientific Foundations Of Vacuum Technique*, John Wiley & Sons, Inc., Second Edition, New York, 1962.
- Redhead, P. A., et al., *Ultrahigh Vacuum*, Chapman and Hall, London, 1968.
- O'Hanlon, J. F., *A User's Guide To Vacuum Technology*, John Wiley & Sons, New York, 1980.

### 3.2 Convectron Gauge Controller Factory Default Settings

The Controller analog output default setting is: 0 to 7 Vdc, Log-linear, 1 V/decade. To change this setting see Section 3.8.

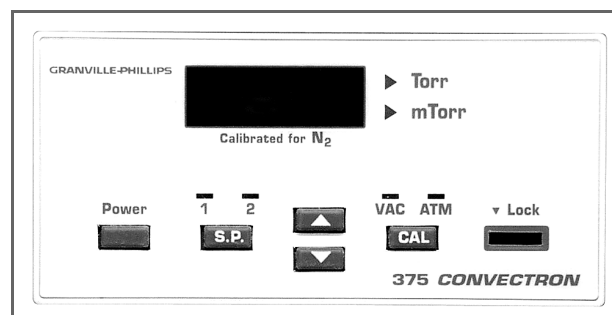
If you have Process Control and/or Computer options see the following sections for their factory default settings:

Process Control — Chapter 4, Section 4.1

RS-232 Interface — Chapter 5, Section 5.2

RS-485/422 Interface — Chapter 6, Section 6.2

### 3.3 Controller Front Panel



**Figure 3-1** Control Unit Front Panel Showing Control and Adjustment Buttons.

### 3.3.1 Switch Overview

- The **Power** switch is push-on, push-off.
- Use the ▲ and ▼ buttons to change settings and parameters.
- The **Lock** security switch disables parameter and setting changes, including the ▲ and ▼ buttons and the **VAC** and **ATM** adjustments. See Section 3.3.2. Parameter lockout does not effect the computer interface.
- You can change one-time setup parameters such as analog output format, communications address, communications parameters, etc. by holding the ▲ and ▼ buttons when the **Power** is turned on. The setup mode is exited and parameters are enabled by cycling the power off and back on again.

### 3.3.2 Lock Switch

The **Lock** switch is provided to secure the Controller parameter settings against unauthorized adjustments. When this locking slide switch is switched to the left, the front keypad is disabled. With the slide switch in the right position the system parameters can be changed as desired. The position of the switch can be secured by removing the front bezel, placing a tamper-proof label over the slide switch opening, and then replacing the bezel.

## 3.4 Gas Type

The Controller is calibrated for N<sub>2</sub> unless otherwise labeled on the front panel for custom applications.



**Warning - If used improperly, Convectron Gauges can supply misleading pressure indications that can result in dangerous overpressure conditions within the system. For use with gases other than air, or N<sub>2</sub> consult the gas type correction charts in Section 3.6.**

## 3.5 Preparing For Convectron Gauge Operation

Convectron Gauge pressure is indicated on the Controller Front Panel Display.

Install pressure limiting devices calibrated to a level that the vacuum system can safely withstand. In addition, install pressure relief valves or rupture disks that will release pressure at a level considerably below the maximum safe pressure level of the system.



**Using the N<sub>2</sub> calibration to pressurize a vacuum system above about 1 Torr with certain other gases can cause dangerously high pressures which may cause explosion of the system. See Section 3.6 before using with other gases.**

Suppliers of pressure relief valves and pressure relief disks are listed in the Thomas Register under “Valves, Relief,” and “Discs, Rupture.” Confirm that these safety devices are properly installed before installing the Series 375 Convectron System. In addition, check that (1) the proper gas cylinders are installed, (2) gas cylinder valve positions are correct on manual systems, and (3) the automation settings are correct on automated gas delivery systems.

*NOTE: Vacuum gauges with compression fittings may be forcefully ejected if the vacuum system is pressurized.*

### 3.6 Understanding Convector Gauge Pressure Measurement In Gases Other Than Nitrogen (or Air)

Convector Gauges are Pirani type thermal conductivity gauges. These gauges measure the heat loss from a heated sensor wire maintained at constant temperature. The controller converts this measurement into gas pressure readings. For gases other than nitrogen or air the heat loss varies at any given true pressure and can result in inaccurate pressure readings.

It is important to understand that the pressure indicated by a Convector Gauge depends on the type of gas, the orientation of the gauge axis, and on the gas density in the gauge. Convector Gauges are normally factory calibrated for N<sub>2</sub> (air has approximately the same calibration). With proper precautions, the Convector Gauge may be used for pressure measurement of certain other gases.

*NOTE: The information in this section applies only when the Convector Gauge is calibrated for N<sub>2</sub> and the Convector Gauge is mounted with its axis horizontal.*

At pressures below a few Torr, there is no danger in measuring pressure of gases other than N<sub>2</sub> and air, merely inaccurate readings. A danger arises if the N<sub>2</sub> calibration is used without correction to measure higher pressure levels of some other gases. For example, N<sub>2</sub> at 24 Torr causes the same heat loss from the Convector sensor as argon will at atmospheric pressure. If the pressure indication of the Convector Gauge is not properly corrected for argon, an operator attempting to fill a vacuum system with 1/2 atmosphere of argon would observe a pressure reading of only 12 Torr when the actual pressure had risen to the desired 380 Torr. Continuing to fill the system with argon to 760 Torr would result in a 24 Torr pressure reading.

Depending on the pressure of the argon gas source, the chamber could be dangerously pressurized while the display continued to read about 30 Torr of N<sub>2</sub> equivalent pressure.

*NOTE: This type of danger is not unique to the Convector Gauge and likely exists with other thermal conductivity gauges using convection to extend the range to high pressures.*

In order to measure the pressure of gases other than air, or N<sub>2</sub> with a Convector Gauge calibrated for N<sub>2</sub>, you must use the conversion curves listed specifically for Convector Gauges to translate between indicated pressure and true pressure. Do not use other data. Never use the conversion curves designed for Convector Gauges to translate pressure readings for gauges made by other manufacturers. Their geometry is very likely different and dangerously high pressures may be produced even at relatively low pressure indications.

*NOTE: You must ensure that the atmosphere adjustments for the Convector Gauge are correctly set. See Section 3.7.*

Figures 3-2 through 3-7 show the true pressure vs. indicated pressure for eleven commonly used gases. Table 3-1 will help to locate the proper graph.

**Table 3-1** Pressure vs. Indicated  $N_2$  Pressure Curve.

Fig. No.	Pressure Range and Units	Gases
3-2	$10^{-4}$ to $10^{-1}$ Torr	All
3-3	$10^{-1}$ to 1000 Torr	Ar, $CO_2$ , $CH_4$ , Freon 12, He
3-4	$10^{-1}$ to 1000 Torr	$D_2$ , Freon 22, Kr, Ne, $O_2$
3-5	$10^{-4}$ to $10^{-1}$ mbar	All
3-6	$10^{-1}$ to 1000 mbar	Ar, $CO_2$ , $CH_4$ , Freon 12, He
3-7	$10^{-1}$ to 1000 mbar	$D_2$ , Freon 22, Kr, He, $O_2$

Note that 1 mbar = 100 Pa, so the mbar charts may be used for Pascal units by multiplying the values on the axes by 100.

A useful interpretation of these curves is, for example, that at a true pressure of  $2 \times 10^{-2}$  Torr for  $CH_4$  the heat loss from the sensor is the same as at a true pressure of  $3 \times 10^{-2}$  for  $N_2$  (see Figure 3-2). The curves at higher pressure vary widely from gas to gas because thermal losses at higher pressures are greatly different for different gases.

If you must measure the pressure of gases other than  $N_2$  or air use Figure 3-2 through Figure 3-7 to determine the maximum safe indicated pressure for the other gas as explained in the examples that follow.

### 3.6.1 Examples

**Example 1 – Maximum safe indicated pressure.**

Assume a given vacuum system will withstand an internal pressure of 2000 Torr or 38.7 psia. For safety, you wish to limit the maximum internal pressure to 760 Torr during the backfilling process. Assume you wish to measure the pressure of Freon 22. On Figure 3-3, locate 760 Torr on the left hand scale, travel to the right to the intersection with the Freon 22 curve, and then down to an indicated pressure of 11 Torr (N<sub>2</sub> equivalent). In this hypothetical situation, the maximum safe indicated pressure for Freon 22 is 11 Torr.

For the sake of safety, it is prudent to place a warning label on the instrument face stating "DO NOT EXCEED 11 TORR FOR FREON 22" for this example.

**Example 2 – Indicated to true pressure conversion.**

Assume you wish to determine the true pressure of helium in a system when the Convector is indicating 10 Torr. On Figure 3-3, follow the vertical graph line up from the 10 Torr (N<sub>2</sub> equivalent) indicated pressure to the Helium curve and then move horizontally to the left to reveal a true pressure of 4.5 Torr. Thus 4.5 Torr Helium pressure produces an indication of 10 Torr (N<sub>2</sub> equivalent).

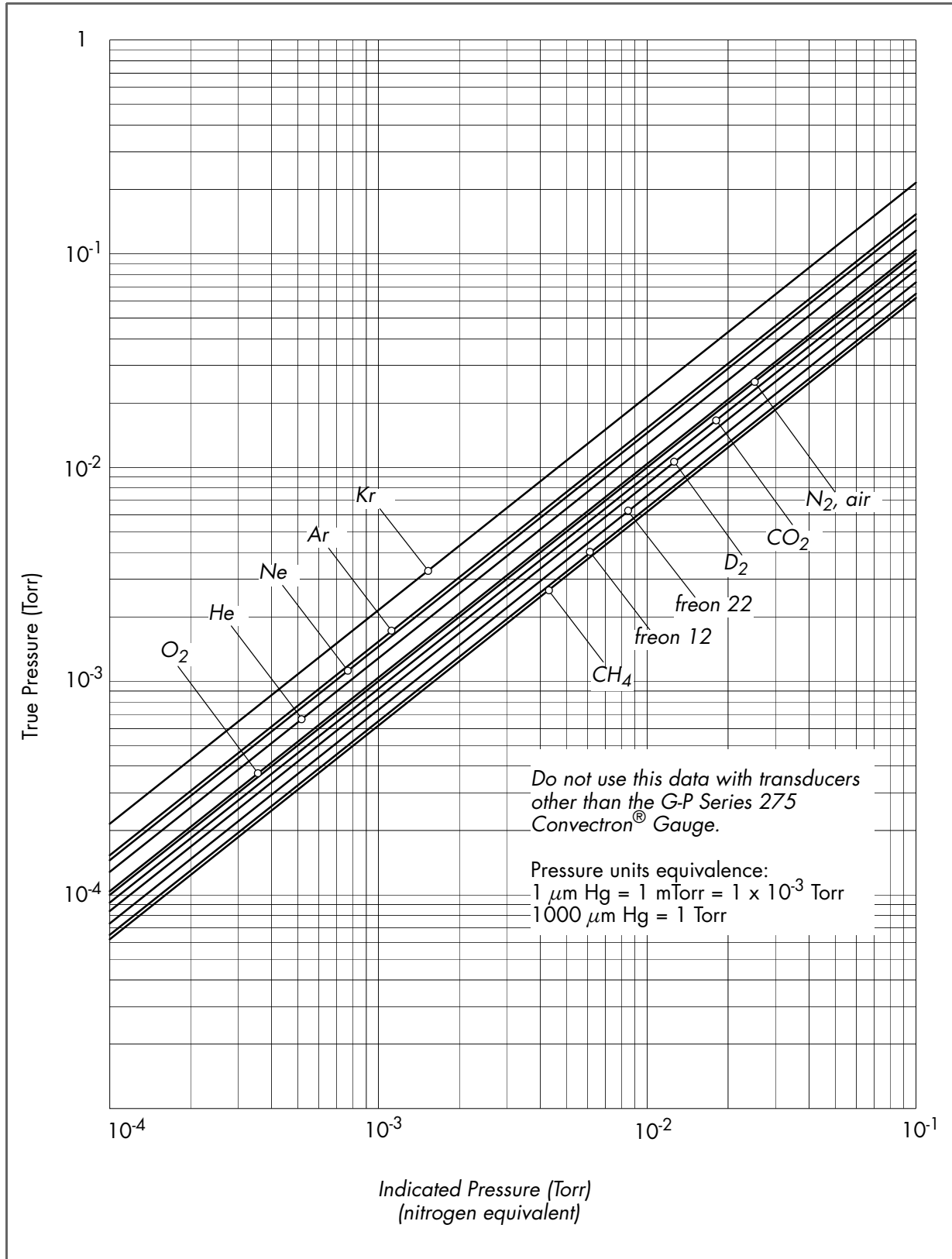
**Example 3 – True to indicated pressure conversion.**

Assume you wish to set a process control setpoint at a true pressure of 20 Torr of CO<sub>2</sub>. On Figure 3-3, locate 20 Torr on the true pressure scale, travel horizontally to the right to the CO<sub>2</sub> curve and then down to an indicated pressure of 6.4 Torr (N<sub>2</sub> equivalent). The correct process control setting for 20 Torr of CO<sub>2</sub> is 6.4 Torr (N<sub>2</sub> equivalent).

**Example 4 – True to indicated pressure conversion.**

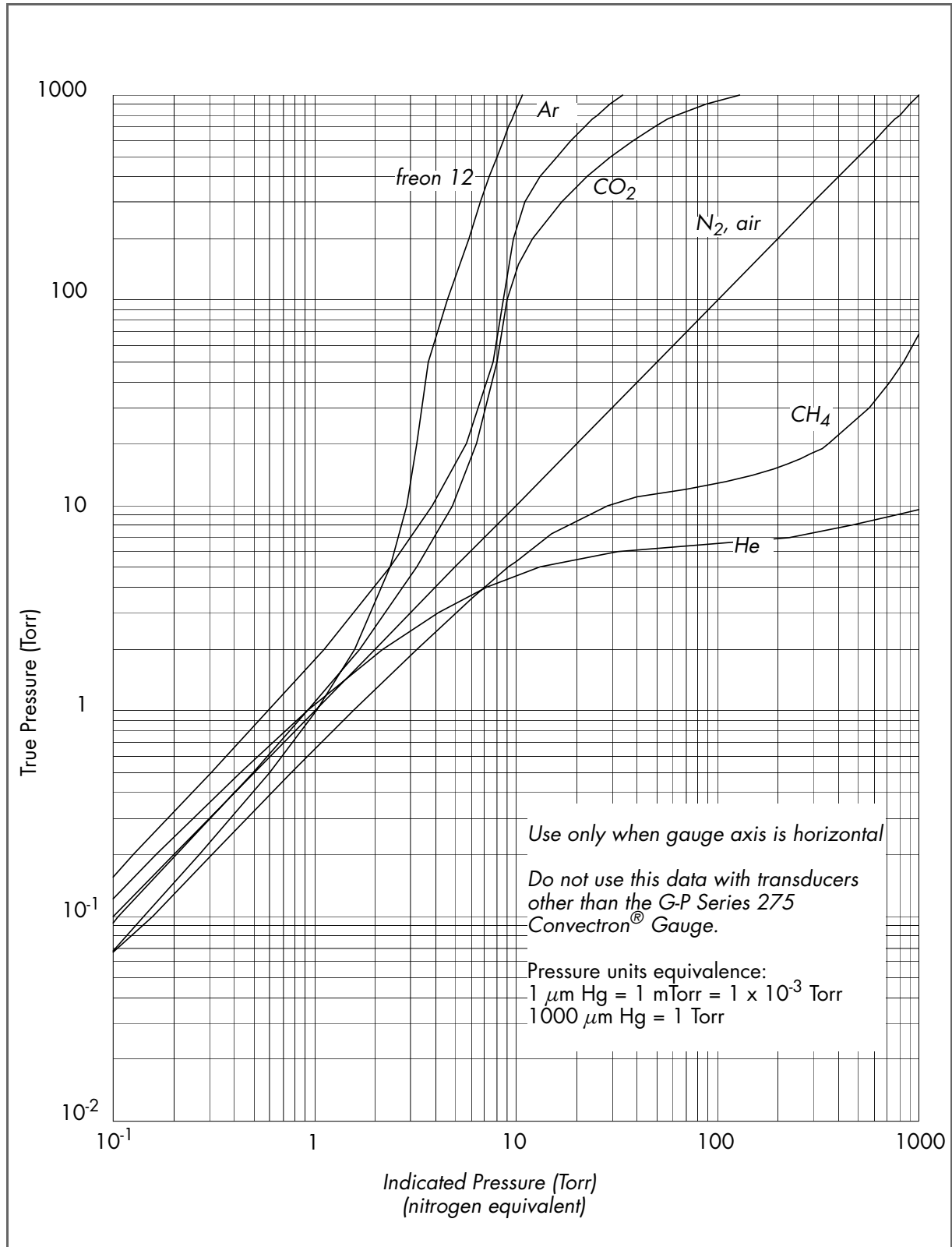
Assume you wish to obtain a helium pressure of 100 Torr in the system. On Figure 3-3, locate 100 Torr on the left hand scale, travel horizontally to the right to attempt to intersect the He curve. Because the intersection is off scale, it is apparent that this true pressure measurement requirement for helium exceeds the capability of the instrument.

*NOTE: For gases other than those listed, the user must provide accurate conversion data for safe operation. The Convector Gauge is not intended for use above approximately 1000 Torr true pressure.*

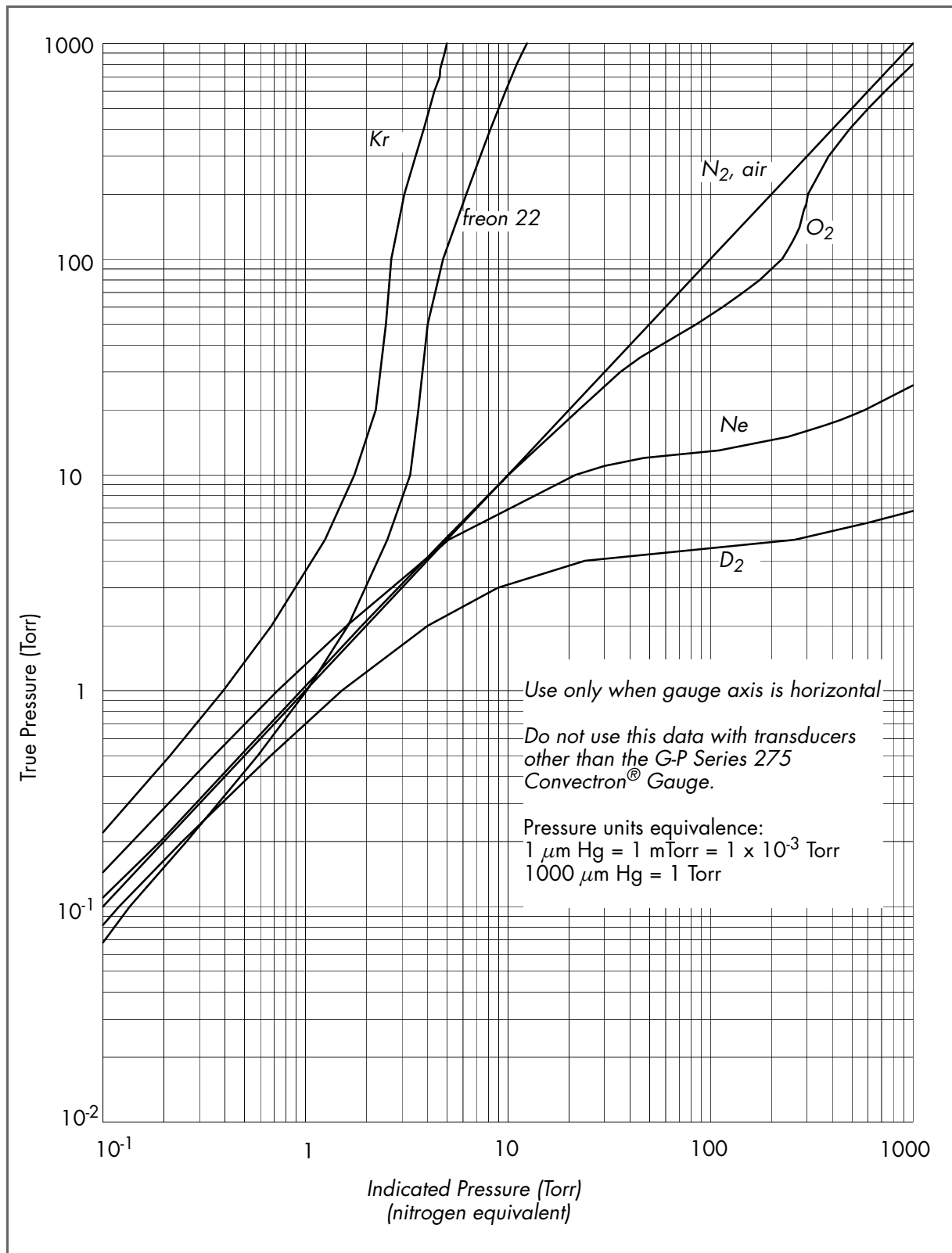


**Figure 3-2** Convector Gauge Indicated vs. True Pressure Curve;  $10^{-4}$  to  $10^{-1}$  Torr.

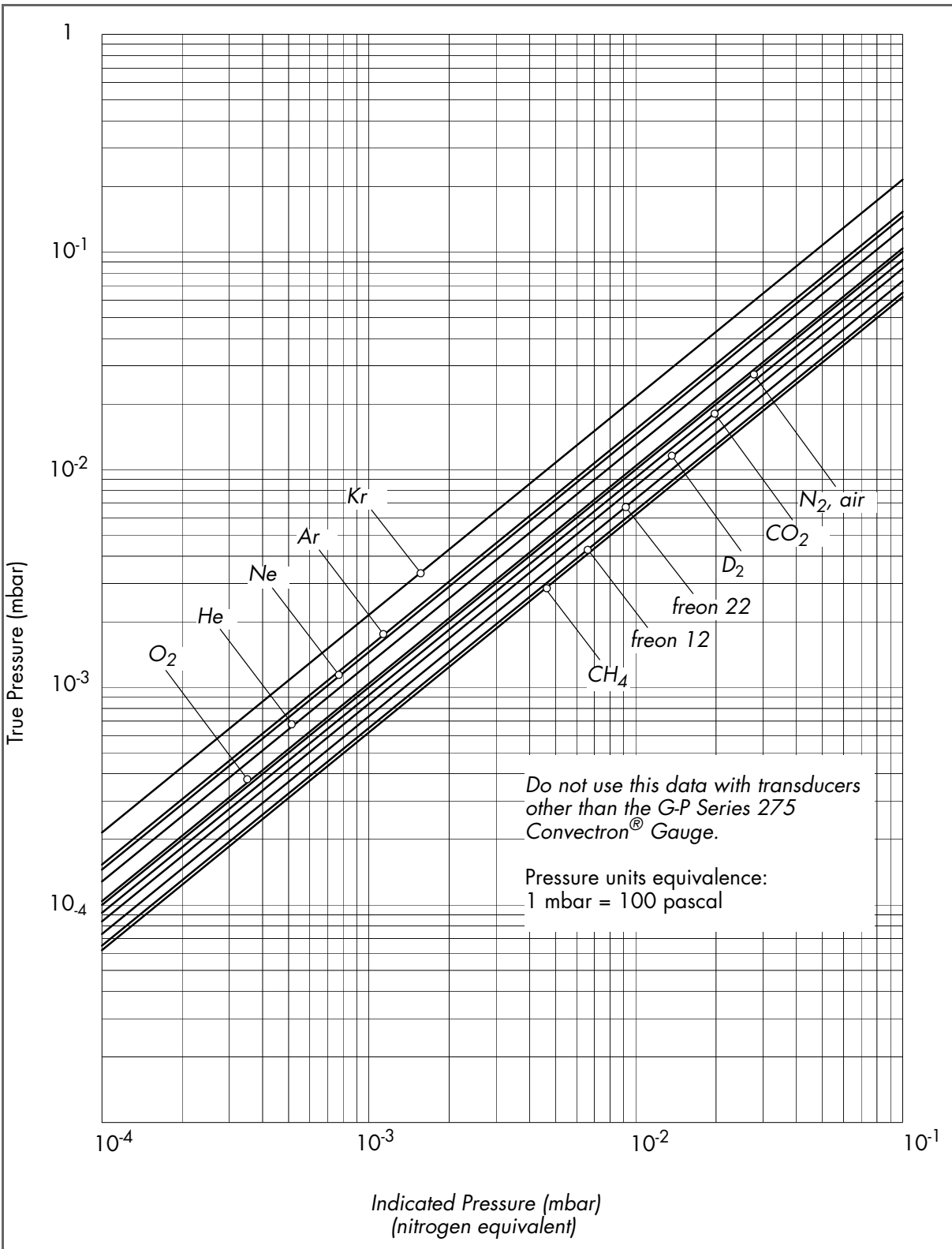




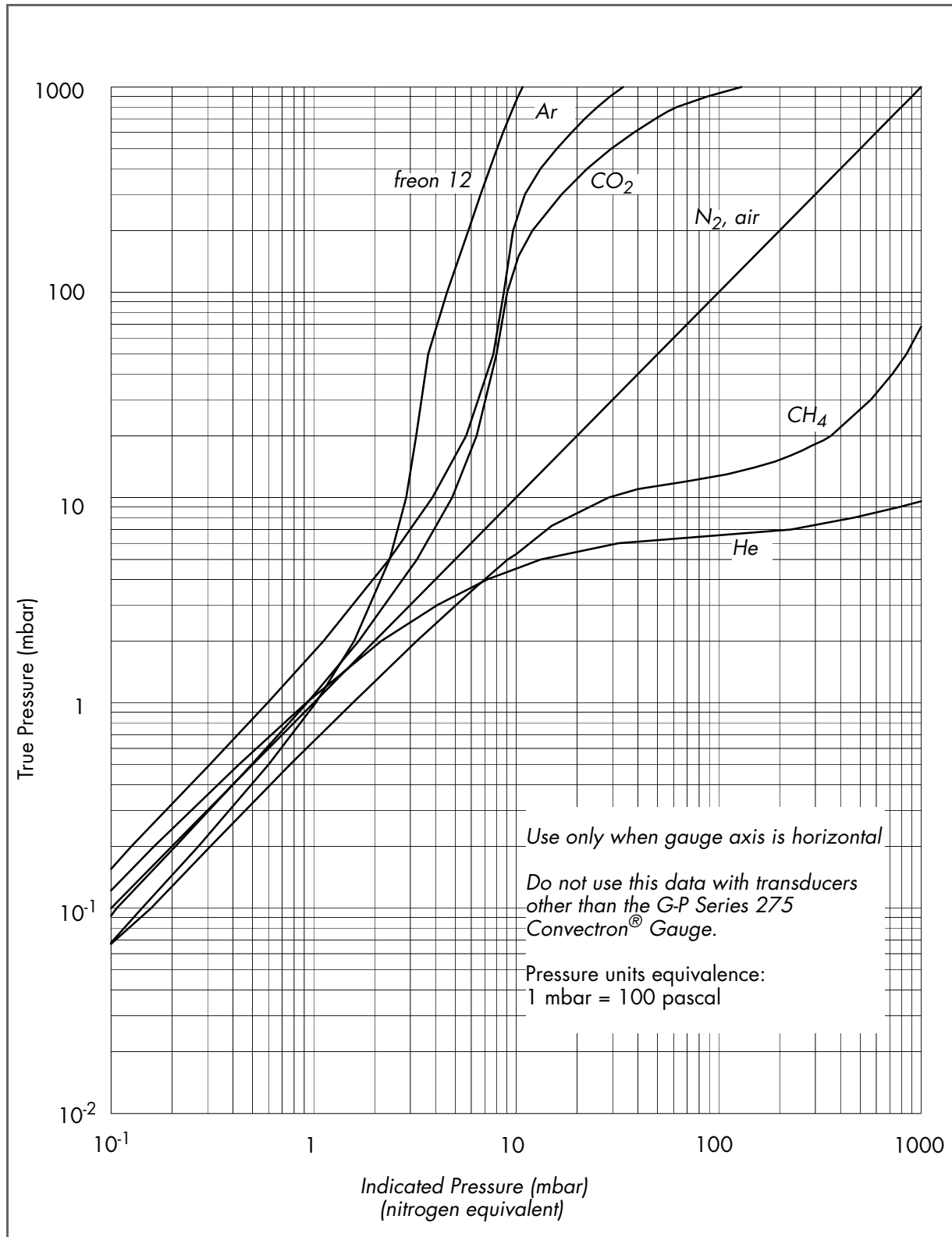
**Figure 3-3** Convectron Gauge Indicated vs. True Pressure Curve;  $10^{-1}$  to 1000 Torr.



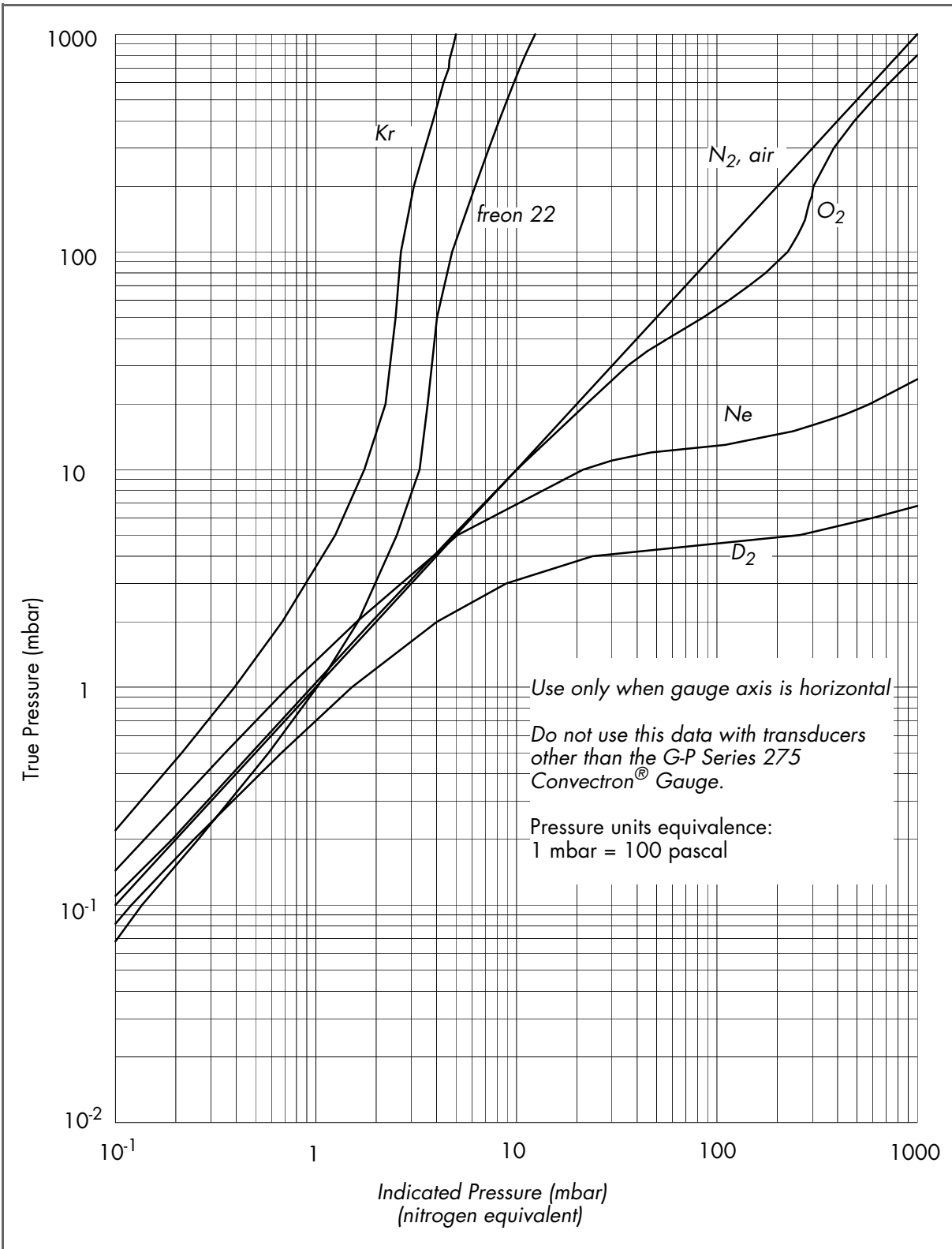
**Figure 3-4** Convectron Gauge Indicated vs. True Pressure Curve;  $10^{-1}$  to 1000 Torr.



**Figure 3-5** Convector Gauge Indicated vs. True Pressure Curve;  $10^{-4}$  to  $10^{-1}$  mbar.




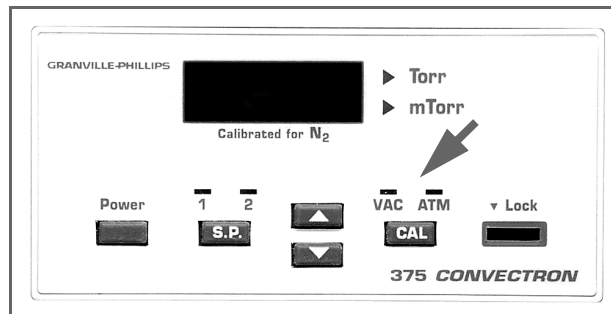
**Figure 3-6** Convector Gauge Indicated vs. True Pressure Curve;  $10^{-1}$  to 1000 mbar.



**Figure 3-7** Convectron Gauge Indicated vs. True Pressure Curve;  $10^{-1}$  to 1000 mbar.

### 3.7 Adjustment of Convector Gauge Zero and Atmospheric Pressure Indications

 **Using the N<sub>2</sub> calibration to pressurize a vacuum system above about 1 Torr with certain other gases can cause dangerously high pressures which may cause explosion of the system. See Section 3.6 before using with other gases.**



**Figure 3-8** Control Unit Front Panel Showing Convector Gauge Zero and Atmospheric Adjustment Button and Indicator Lights.

Each Convector Gauge is individually computer calibrated for N<sub>2</sub>. Zero adjustment of the gauge should not be necessary unless readout accuracy is required below  $1 \times 10^{-3}$  Torr or the gauge has been contaminated. Adjustment of the atmospheric indication should not be necessary unless compensating for long cables, variations in mounting orientation, or contamination.

The Convector Gauge has a stable, temperature compensated design. Each controller is also calibrated to provide accurate readout of N<sub>2</sub> pressure with any Convector Gauge when properly installed with the gauge axis horizontal.

For accurate readout, the vacuum and atmosphere adjustments must be made in the following order.

1. Evacuate Convector Gauge to a pressure known to be less than  $1 \times 10^{-5}$  Torr of N<sub>2</sub>.
2. With power on and at a pressure less than  $1 \times 10^{-5}$  Torr for at least 15 minutes, press the **CAL** button. When the **VAC** indicator light is flashing the Controller will display **0.0** Torr/mbar/Pa. Press **CAL** again to store the reading and exit the calibration mode.
3. Let the pressure in the gauge increase to the local atmospheric pressure.
4. Read the local atmospheric pressure on an accurate barometer nearby.
5. With the power on, press the **CAL** button. When the **ATM** indicator light is flashing press the ▲ or ▼ buttons to change the pressure reading until the gauge display indicates the local atmospheric pressure in the pressure units you are using. Press **CAL** again to save the pressure reading and exit the calibration mode.

6. If you are unable to pump your system to less than  $1 \times 10^{-5}$  Torr and the pressure is known using an accurate reference gauge, you can adjust **VAC** at pressures up to  $10^{-1}$  Torr. Press the **CAL** button, and then press the **▲** or **▼** buttons until the Controller display indicates the desired pressure value as determined by a calibrated gauge. Continue to Step 3 for **ATM** calibration.

To reset **VAC** and **ATM** back to their original factory settings, turn off the Controller and hold **CAL** while turning the Controller power back on. "**FAC**" is displayed for approximately 3 seconds. The Controller will then resume normal power-on operation. To enable this function the **Lock** switch must be turned off. See Section 3.3.2.

### 3.7.1 Special Considerations for Convectron Gauge Use Below $10^{-3}$ Torr

During a fast pumpdown from atmosphere, thermal effects will prevent the Convectron Gauge from tracking pressure accurately below  $10^{-3}$  Torr. After waiting about 15 minutes, indications in the  $10^{-4}$  range will be valid and response will be rapid. Zero adjustment at vacuum may be performed at this time (or sooner if readings in the  $10^{-4}$  range are not needed). In the  $10^{-4}$  Torr range, the indication is resolved to about 0.1 millitorr provided the instrument has been carefully zeroed at vacuum. For accurate use in the  $10^{-4}$  range, zeroing should be repeated frequently.

### 3.7.2 375 NIST Traceable System Calibration

Brooks Automation/Granville-Phillips offers a calibration service for the 375 Controller / 275 Convectron gauge system. A 375 Controller and 275 gauge tube are calibrated as a system, the built-in calibration functions of the Controller are locked, and a calibration certificate is provided to the customer.

#### 3.7.2.1 375 Controller Function after System Calibration

The **ATM** and **VAC** LED's on the front panel serve as visual indicators that the NIST traceable calibration parameters are being used in the memory of the 375. While **both** **ATM** and **VAC** LED's are lit, the specific calibration is valid. The Controller cannot be calibrated—the **CAL** button does nothing (also the TS, TZ and FAC commands of the computer interface do nothing but respond **INVALID\_CR**).

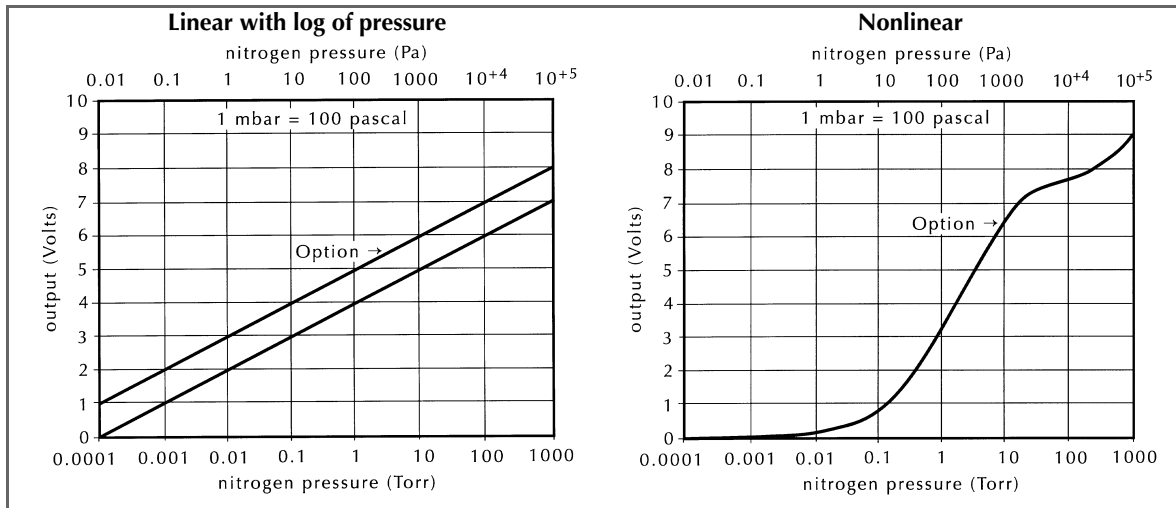
#### 3.7.2.2 Voiding the System Calibration

To set **VAC** or **ATM**, thereby voiding the NIST traceable calibration, the user must first unlock the calibration functions. This is achieved by either holding down the **SP** and **▲** buttons while turning on the power or sending the command **VC** (Void Calibration) through the computer interface (see Section 5.6.1, or Section 6.6.1). The **ATM** and **VAC** LED's will turn off, indicating that the controller can now be calibrated. (Cycling the power, or sending "**RST**" (Reset), at this point would keep the NIST traceable calibration parameters in the memory.) The Controller can then be calibrated at **VAC** or **ATM** as described in Section 3.7.

### 3.8 Convector Gauge Analog Output Signal

A voltage output signal proportional to the common logarithm of the pressure indication is provided on the rear panel of the Convector Gauge module via a standard  $\frac{1}{8}$  in. miniature phono jack.

If graphed on log-linear axes, the output voltage is linear with respect to the log of pressure. See Figure 3-9. The analog output is 1 volt per decade of pressure with a factory adjusted output of 0 volts at  $1.0 \times 10^{-4}$  Torr. An output voltage of 10 V indicates the gauge is unplugged or faulty.



**Figure 3-9** Convector Gauge Analog Output vs. Pressure.

The voltage signal is smooth and continuous throughout all the decades of pressure measurement. This format is useful for computerized data acquisition because a simple equation (finding the common antilogarithm) may be programmed to calculate pressure from the voltage output.

The output equation is:

$$P_i = 10^{V-4} \text{ Torr/mbar, or } P_i = 10^{V-2} \text{ Pascal}$$

where:  $P_i$  = Pressure indication

$V$  = analog output voltage

and: the offset is the factory adjusted to 0V at  $10^{-4}$  Torr ( $10^{-2}$  Pa).

#### 3.8.1 Optional Analog Output of 1 to 8 V

In some applications a 0 V output is used to indicate that the Controller is off. To accommodate these situations a one volt offset is available as an alternative.

For this optional output format, a  $-0.0$  indication produces 0.5 V output. A 10 V output means the gauge is unplugged or faulty.

If the offset is adjusted to 1V at  $10^{-4}$  Torr ( $10^{-2}$  Pa), then the output equation is:

$$P_i = 10^{V-5} \text{ Torr/mbar, or } P_i = 10^{V-3} \text{ Pascal}$$



You may change the output to the 1 to 8 V analog output format. See Figure 3-10.

1. Enter the setup mode by holding the ▲ and ▼ buttons down during power-up.
2. Press the ▲ or ▼ buttons until the display reads **1.02**.
3. Press the **CAL** button to store the value.
4. Return to operational mode by turning the Controller off and then on again.

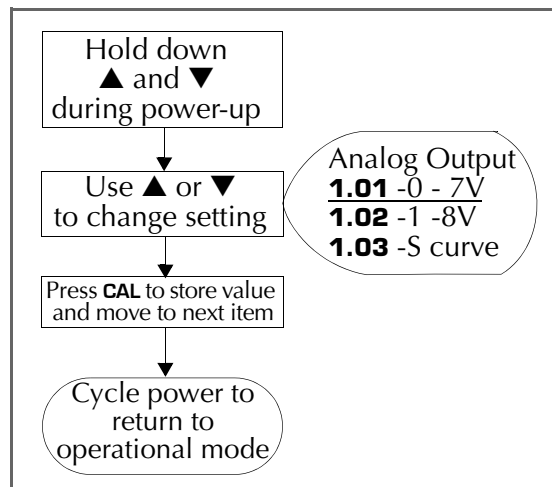
### 3.8.2 Optional Nonlinear Analog Output “S Curve”

In some applications a 0 to 9 V output similar to the Series 275 Controller output is desirable. To accommodate these situations a third analog output option is available.

You may obtain the nonlinear “S Curve” output. See Figure 3-10.

1. Enter the setup mode by holding the ▲ and ▼ buttons down during power-up.
2. Press the ▲ or ▼ buttons until the display reads **1.03**.
3. Press the **CAL** button to store the value.
4. Return to operational mode by turning the Controller off and then on again.

A 10 V output means the gauge is unplugged or faulty.



**Figure 3-10** Flow Diagram for Setting Analog Output.

## NOTES

The Process Control Option provides a convenient method of organizing and establishing automatic control of vacuum system operations. Control is based on configuring pressure setpoints to activate relays in the Controller. A total of 2 setpoints are available and can be assigned as shown in Table 4-1, below.

### 4.1 Process Control Factory Default Settings

Table 4-1 lists the default settings for the Process Control option. The right hand column lists the section of the manual you can go to for more information about default settings and/or detailed instructions on changing defaults.

**Table 4-1** Guide to Manual Sections for Changing Default Setting.

Feature	Default Setting	Manual Section
Setpoints 1 and 2	Setpoint,— 0.0	Section 4.4
	Relay Polarity—Relay activation below pressure setpoint; (–)	Section 4.4
	Returning Pressure Hysteresis—10% (not changeable)	Section 4.4

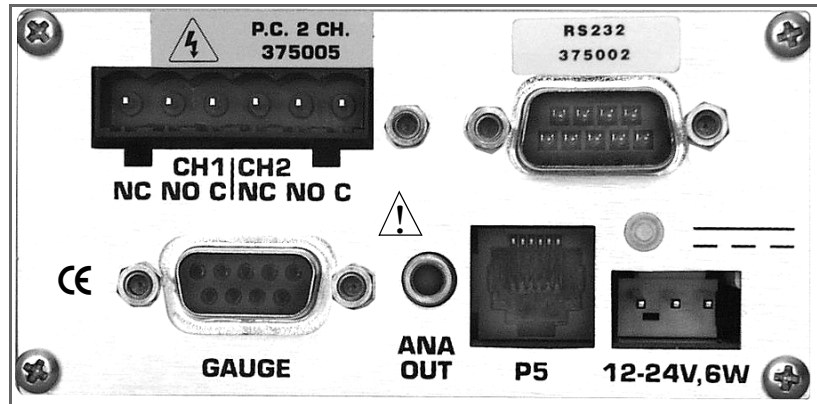
### 4.2 Process Control Setup

1. Use the catalog number on the rear of the Controller to identify the process control capability installed in your unit.
2. Even if the control logic is simple and obvious, we recommend that you develop a logic diagram of the process control function.
3. Prepare a specification table that lists the proposed pressure setting, system measurement point, and relay status for each Process Control setpoint.
4. Draw a circuit schematic which specifies exactly how each piece of system hardware will be connected to the Process Control relays.
5. Do not exceed the relay ratings shown below:

Relay Configuration	Form C – NC, C, NO (Normally Closed, Common, Normally Open)
Relay Contact Rating	5 A, 250 Vac, 30 Vdc, resistive load

6. Attach a copy of the Process Control circuit diagram to this manual for future reference and troubleshooting.
7. The required process control connections may be made later. See Section 4.3.

8. If you desire application assistance, please contact a Brooks Automation/Granville-Phillips Application Engineer at the number listed on the title page of this manual.



**Figure 4-1** Two Setpoint Process Control - Cat. No. 375005 Back Panel, Showing Output Connector Pin Assignments.

### 4.3 Connecting Process Control Relays

Instructions for setting up this module are in Section 4.2.

The process control connector, located on the rear panel of the Control Unit, is marked with letters identifying each pin. Figure 4-1 shows the 3 pins assigned to each channel.

A mating connector (G-P Part No. 013640) is supplied in the hardware kit.

1. Using a drawing of the Process Control Output Connector and the circuit schematics you have prepared, make a cable to connect the various system components to be controlled. Clear labeling of each lead will help prevent costly mistakes.
2. Connect the Controller end of the cable to the system component to be controlled. This is done with a small screwdriver and screw-post connections.
3. Plug the connector into the back of the Control Unit.
4. Refer to Section 4.4 for instructions on setting setpoints.

## 4.4 Setpoint Display and Adjustment

The **S.P.** button is used only for viewing and changing process control setpoints.

The **S.P.** button is used to select either setpoint 1 (S.P.1) or setpoint 2 (S.P.2) for programming. The setpoints are displayed in the main pressure display with a flashing indication on the S.P.1 or S.P.2 LED to indicate that the setpoint, not the pressure, is being displayed. The minus sign (–) indicates that the relay will activate at the setpoint on falling pressure, i.e. pumping down. The plus sign (+) indicates that the relay will activate at the setpoint on rising pressure. To view the setpoint, press **S.P.** once for S.P.1 (setpoint 1), again for S.P.2 (setpoint 2), and once more to go to the operational mode. When SP1 or SP2 is being displayed, use the ▲ and ▼ keys to change the setpoint pressures. The **Lock** switch must be off to change setpoints. See Section 3.3.2. Scrolling to the end of the setpoint pressure range will cause the + or – indicator to change. After making changes, pressing the **S.P.** button will return to the operational mode and store the changed setpoint pressure.

## 4.5 Process Control Tips

Relay actuation occurs when the pressure reading is greater than the setpoint (for + polarity), or is less than the setpoint (for – polarity.) A 10% hysteresis is automatically programmed into each setpoint for returning pressures. Table 4-2 illustrates this function using an assumed setpoint pressure and also assumes that the polarity is set to activate the relay when pressure falls below the setpoint.

**Table 4-2** Setpoint Hysteresis. (–)

Setpoint Pressure	Pressure Change	Relay Transition Pressure
$-6.30 \times 10^{-2}$	Falling	$< 6.30 \times 10^{-2}$
$-6.30 \times 10^{-2}$	Rising	Releases at $6.30 \times 10^{-2} + 10\% = 6.93 \times 10^{-2}$

**Table 4-3** Setpoint Hysteresis. (+)

Setpoint Pressure	Pressure Change	Relay Transition Pressure
$+6.30 \times 10^{-2}$	Rising	$> 6.30 \times 10^{-2}$
$+6.30 \times 10^{-2}$	Falling	Releases at $6.30 \times 10^{-2} - 10\% = 5.67 \times 10^{-2}$

## 4.6 4-Channel Process Control

Some models of the Series 375 Convectron Gauge Controller may have a 4-Channel Process Control board. This section provides detailed information regarding use of that option.

### 4.6.1 Process Control Factory Default Settings

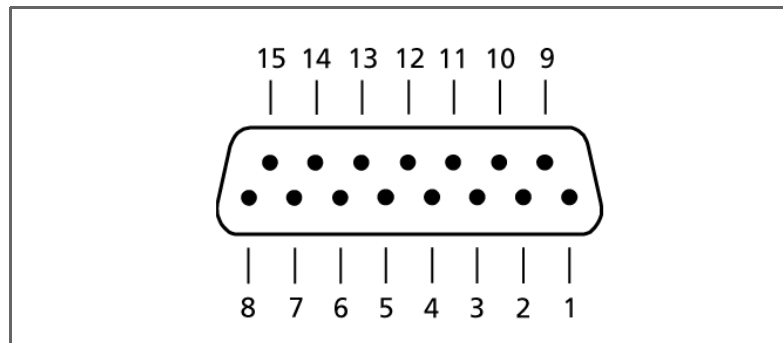
Setpoints 1 through 4 are all factory set to -0.0. ("-") means relay actuation with pressure less than setpoint.)

### 4.6.2 Relay Contact Ratings

The contacts are rated at 0.5A, 115 Vac, resistive load.

**Table 4-4** Pin assignments of 15-Pin D-connector on the Process Control Board

Relay	Common (C)	Normally Open (NO)	Normally Closed (NC)
1	9	1	2
2	11	3	4
3	13	5	6
4	15	7	8



**Figure 4-2** 15-Pin Process Control Connector (subminiature D male)

### 4.6.3 Computer Interface Commands

The commands that access the process control setpoints (PC and PCP) on the 4-channel process control board work exactly as the 2-channel process control board. Allowed modifiers are 1, 2, 3, and 4. Select the desired relay setpoint. See Section 5.6.1 and Section 4.6.1 for more detailed information.

## 5.1 RS-232 Computer Interface Setup

This option permits data output to, and gauge control by, a host computer. Output control is either by a command-response mechanism or a hardwire control line between RTS and CTS. If you have this module in your unit, configure it to your system requirements as directed in this chapter.

A variety of baud rates and byte framing options are available

## 5.2 RS-232 Computer Interface Factory Default Settings

The following table lists the default settings for the RS-232 Computer Interface option. The right hand column lists the section of the manual you can go to for more information about default settings and detailed instructions on changing defaults.

**Table 5-1** Guide to Manual Sections for Changing Default Setting.

Feature	Default Setting	Manual Section
Baud Rate	19.2 kbaud	Section 5.3.1
Byte Format	8 data bits, No parity; 1 stop bit; RTS/CTS Disabled	Section 5.3.2

## 5.3 RS-232 Computer Interface Settings

### 5.3.1 Baud Rate

1. Enter the setup mode by holding the ▲ and ▼ keys down during power-up.
2. Press the **CAL** button until the Controller display shows **2.05** (or some other number beginning with 2.) See Table 5-2.
3. Press the ▲ or ▼ keys to select the baud rate. See Table 5-2.

**Table 5-2** Baud Rate Display Readouts.

Display Readout	Baud Rate
<b>2.01</b>	1,200
<b>2.02</b>	2,400
<b>2.03</b>	4,800
<b>2.04</b>	9,600
<b><u>2.05</u></b>	<u>19,200</u>

4. Press the **CAL** button to store the value.
5. To select the byte format go to Section 5.3.2 Step 3.  
If you do not need to make any more changes, return to operational mode by turning the Controller off and then on again. For additional changes continue on to the next section.

### 5.3.2 Selecting the Byte Format

1. Enter the setup mode by holding the ▲ and ▼ keys down during power-up.
2. Press the **CAL** button so that the Controller display shows **3.01** (or some other number beginning with **3.**)
3. Press the ▲ or ▼ keys to select the byte format. See Table 5-3.

**Table 5-3** *Byte Format Display Readouts.*

Display Readout	Byte Format
<b>3.01</b>	8 data bits, no parity, 1 stop bit
<b>3.02</b>	7 data bits, odd parity, 1 stop bit
<b>3.03</b>	7 data bits, even parity, 1 stop bit

4. Press the **CAL** button to store the value and cycle power to return to operational mode. For additional changes continue on to Section 5.3.3.

### 5.3.3 Handshaking

Normal handshake control can be accomplished using the command-response mechanism, or for a hardwired handshake by using the RTS/CTS connection as outlined in Table 5-4. This RTS/CTS connection will have to be enabled via a separate function. See Section 5.3.4.

**Table 5-4** *Handshaking Outputs from 375 Controller.*

Line	Pin	Description	Factory Setting
RTS	8	Output from 375 to be tied to computer's CTS input for hardware handshake control.	Always high
CTS (input)	7	Input to 375. Used to sense the RTS line of the computer before sending data.	No control of data output.
DTR (output)	6	Set high when 375 is turned on.	n.a.

### 5.3.4 Enabling the RTS/CTS Connection

1. Enter the setup mode by holding the ▲ and ▼ keys down during power-up.
2. Press the **CAL** button until the Controller display shows **4.01**.
3. Press the ▲ or ▼ keys to enable the RTS/CTS handshake (display shows **4.02**). See Table 5-5.



**Table 5-5** *RTS/CTS Handshake Display Readouts.*

Display Readout	Byte Format
<b>4.01</b>	<u>disable RTS/CTS handshake</u>
<b>4.02</b>	enable RTS/CTS handshake

Upon receiving the terminator, the 375 will assert the RTS line as a holdoff to prevent the host computer from attempting to transmit further data until the message just received has been parsed and a reply has been sent.

During the transmission of the reply, the CTS incoming handshake line is tested prior to transmission of each character. The 375 will wait until CTS is true before beginning transmission of a character, and will not test it again until ready to begin transmitting the next.

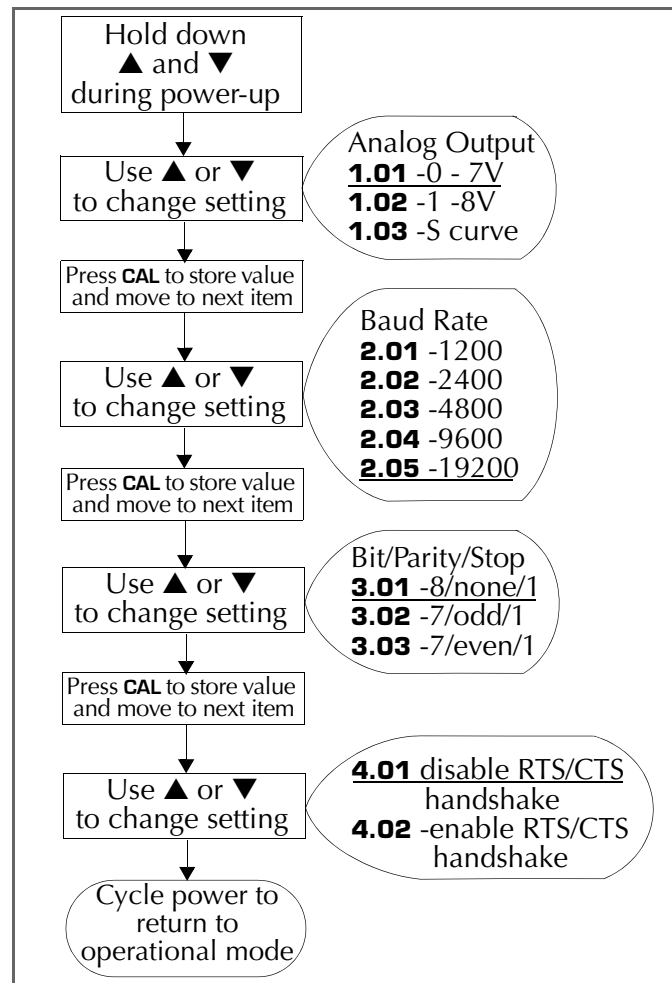
After transmitting the terminator, the 375 will negate RTS and wait for the next incoming message.

To summarize:

**CTS** – Set by the computer to indicate that the 375 may transmit the next byte in its message. As shipped from the factory, these lines are disabled. The 375 will automatically assume the host is ready to receive.

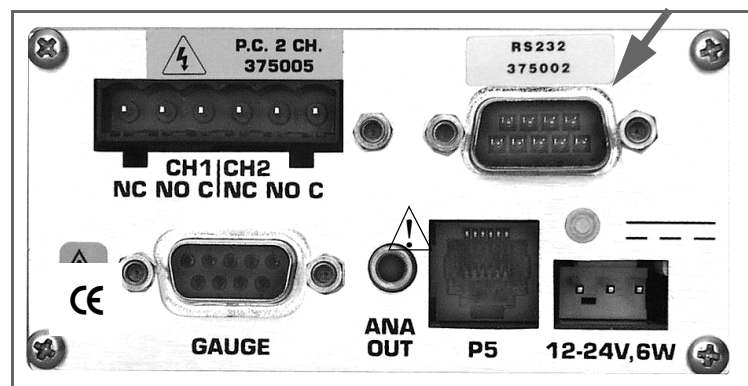
**DSR** – Always asserted by the 375. A “power on” indication.

**RTS** – Negated by the 375 on power-up. Asserted by the 375 upon receipt of a message terminator. Negated after transmitting the terminator of the 375's response to that message.



**Figure 5-1** Flow Chart Showing Setup Sequence for Baud Rate, Character Framing, and RTS/CTS Handshake.

## 5.4 Connecting the RS-232 Computer Interface



**Figure 5-2** Control Unit Rear Panel Showing RS-232 Connector.

Instructions for setting up this interface are in Section 5.3.

This factory or field installed option produces the signals shown in Table 5-6.

A mating 9 pin D type connector is supplied in the hardware kit. Use shielded cable to minimize electromagnetic radiation or susceptibility. Ground the shield to the metal connector shell or to Pin 5. Do not connect the shield to Pin 7.

**Table 5-6** RS-232 Connector Pin Assignments.

Signal	Pin Number	Direction
Signal/Ground	5	-
Transmitted Data (TXD)	2	To Computer
Received Data (RXD)	3	To 375
Data Set Ready (DSR)	6	To Computer (DSR)
Clear to Send (CTS)	7	To 375
Request to Send (RTS)	8	To Computer

The DSR line is set true by the 375 on power up to indicate it is on. When the 375 receives a start bit on the received data line, it will input and buffer a character. The 375 will continue to receive and buffer characters until it receives the terminator (CR).

#### 5.4.1 9-Pin RS-232 Interconnection to Computer

**Table 5-7** Computer Cable Pin Assignments for a 9 Pin Connector.

Signal at Computer	PC/AT Connector DE9P (DE25P)	Cable pinout DE9SDB9P (DE25S)	375 Connector DB9S	Signal at 375
RXD	2 (3)	2 (3) 2	2	TXD
TXD	3 (2)	3 (2) 3	3	RXD
Signal Ground	5 (1)	5 (1) 5*	5	Signal Ground
CTS	8 (5)	8 (5) 8	8	RTS
RTS	7 (4)	7 (4) 7	7	CTS
DSR	6 (6)	6 (6) 6	6	DSR

\* Use metal connector shell to provide shield wire ground.

Section 5.6 contains instructions for communicating using the RS-232 Computer Interface.

## 5.5 Preparing for Use of the RS-232 Computer Interface

See Section 5.4 for connection instructions.

Check the user's manual for the host computer to be sure the protocol used is compatible with that established via the configuration of the RS-232 module.

Communication with the Control Unit is via ASCII strings. A message consists of a command and a command modifier, followed by a terminator. The message may contain leading spaces, and the command and modifier may optionally be separated by spaces or commas. No spaces may appear within the command or the modifier, only between them.

The terminator expected by the Control Unit is an ASCII carriage return, denoted here by *CR*. The line feed is optional, and messages terminated with only the carriage return will be accepted. Note that the *LF* terminator may be appended automatically by the host computer's interface software to the message string supplied by the user. This line feed will be ignored.

If extra characters are found in the message after it has been successfully interpreted but before the terminator, they will be ignored. Characters can be upper- or lower-case. All messages to the 375 will receive a reply, consisting of an ASCII string of upper-case letters terminated with *CR*. Pressures will be returned in the format X.XXE±XX.

## 5.6 RS-232 Command Syntax

Command from host must include data and a terminator. (data)(terminator)

The data field is explained in the command descriptions. All alpha characters can be upper or lower case.

All data fields responses will contain 9 upper case alphanumeric characters. A response of **SYNTAX\_ER CR** is caused by an incorrect character string from the host.

### 5.6.1 Command Descriptions

#### RD

Definition: Read Convectron Gauge pressure response.

Modifiers: None.

Response: Pressure Value (x.xxE±xx)

Other possible responses:

**OPN\_SNSR CR** — Defective transducer

**SNSR\_UNP CR** — Sensor is unplugged

**SNSR\_OVP CR** — Pressure higher than 999 Torr, or gasses other than nitrogen in the system. (Atmosphere pressure of helium will cause this response.)

Example: From host: **RD CR**  
From 375: **9.34E-02 CR**

#### NOTES:

1. \_ = space, CR = Carriage Return
2. ASCII string representing pressure in scientific notation. Three significant digits except in  $10^{-3}$  Torr range with 2 significant digits and a zero filler,  $10^{-4}$  Torr range with 1 significant digit with 2 zero fillers.
3. While at vacuum, the output should be 0.00E-04 (= 0.0 mTorr displayed.) Output 0.00E+00 (= -0.0 mTorr displayed) occurs when the transducer voltage at vacuum has drifted lower than that set by the TZ command. The number received at vacuum will fluctuate under normal operation, but if it reads negative consistently, calibration may be required. See Section 3.7 or TZ Command on page 46.

#### TS

Definition: Set span (typically at atmospheric pressure).

Modifiers: Pressure Value (Pressure must be above 399 Torr.)

Response: **PROGM\_OK**

Other possible responses:

**GAIN\_LIM CR** — Gain programmed at limit. Readout will be the pressure at max TS setting.

**OPN\_SNSR CR** — Sensor defect, no change in programming. See Maintenance, Section 7.4.

**SNSR\_UNP CR** — Sensor unplugged, no change in programming.

**RANGE-ER CR** — Command error. TS must be set above 399 Torr, and system pressure must be above 399 Torr.

**INVALID\_CR** — System is calibrated and locked.

Example: From computer: **TS 7.60E+02 CR**  
From 375: **PROGM\_OK CR**

**NOTE:**

Do this only at pressures above 399 Torr; it will respond with range error if done near vacuum. The change occurs as soon as the function is performed.

If a **TS** command is sent while the ATM setting is being changed with the **CAL** button on the front panel, the command is disregarded and the response is **F\_P\_ERR**. The **CAL** button has priority over the **TS** command to set the ATM setting. If the Controller is system-calibrated, the response for this command will be **INVALID\_CR**. See Section 3.7.2.

**TZ**

Definition: Set zero.

Modifiers: 0 or pressure below  $1 \times 10^{-1}$  Torr in scientific notation.

Response: **PROGM\_OK**

Other possible responses:

**OFST\_LIM CR** — Offset programmed at limit. Readout will be the pressure at max TZ setting.

**OPN\_SNSR CR** — Sensor defect. No change in programming. See Maintenance, Section 7.4.

**SNSR\_UNP CR** — Sensor unplugged. No change in programming.

**RANGE\_ER CR** — Command error. TZ must be set below  $1 \times 10^{-1}$  Torr, and system pressure must be below  $1 \times 10^{-1}$  Torr.

**INVALID\_CR** — System is calibrated and locked.

Examples: From computer: **TZ0 CR**  
From 375: **PROGM\_OK CR**  
From computer: **TZ1.00E-02 CR**  
From 375: **PROGM\_OK CR**

**NOTES:**

Do this only at pressures below  $1 \times 10^{-1}$  Torr. The response will be a range error if done near atmosphere. Change occurs as soon as the function is performed

If a **TZ** command is sent while the VAC setting is being changed with the **CAL** button on the front panel, the command is disregarded and the response is **F\_P\_ERR**. The **CAL** button has priority over the **TZ** command to set the VAC setting. If the Controller is system-calibrated, the response for this command will be **INVALID\_CR**. See Section 3.7.2.

**FAC**

Definition: Set factory default.  
Modifiers: None.  
Response: **PROGM\_OK CR**  
Example: From computer: **FAC CR**  
From 375: **PROGM\_OK CR**

## NOTE:

Cycle power or send RST after doing this function. FAC will cause default VAC and ATM parameters to be programmed to factory default settings. If the Controller is system-calibrated, the response for this command will be **INVALID\_CR**. See Section 3.7.2.

**SB**

Definition: Set baud rate.  
Modifiers: 1200, 2400, 4800, 9600, 19200  
Response: **PROGM\_OK CR**  
Example: From computer: **SB2400 CR**  
From 375: **PROGM\_OK CR**

## NOTE:

The Controller will continue to operate at the old baud rate until power is cycled or RST command is sent. The Maximum baud rate is 19.2 kbaud. The baud rate needs to be set at a valid rate, i.e., 1200, 2400, 4800, 9600, 19200. If the rate is set to an odd value, for example 2234, the Controller will stay at the present rate and respond with **SYNTAX\_ERROR**.

**SPN**

Definition: Set bits/parity to 8 bits/none, 1 stop bit.  
Modifiers: None.  
Response: **PROGM\_OK CR**  
Example: From computer: **SPN CR**  
From 375: **PROGM\_OK CR**

## NOTE:

Cycle power or send RST after doing this function to enable changes.

**SPO**

Definition: Set bits/parity to 7 bits/odd, 1 stop bit.  
Modifiers: None.  
Response: **PROGM\_OK CR**  
Example: From computer: **SPO CR**  
From 375: **PROGM\_OK CR**

## NOTE:

Cycle power or send RST after doing this function to enable changes.

### **SPE**

Definition: Set bits/parity to 7 bits/even, 1 stop bit.

Modifiers: None.

Response: **PROGM\_OK CR**

Example: From computer: **SPE CR**  
From 375: **PROGM\_OK CR**

#### NOTE:

Cycle power or send RST after doing this function to enable changes.

### **PCP**

Definition: Set the polarity of the relay activation. (Factory default is –)

Modifiers: 1 or 2; + or –

Response: **PROGM\_OK CR**

Example: From computer: **PCP1 +CR**  
From 375: **PROGM\_OK CR**  
or **INVALID** if option not installed

#### NOTE:

If a **PCP** command is sent while the setpoints are being changed with the **S.P.** button on the front panel, the command is disregarded and the response is **F\_P\_ERR**. The **S.P.** button has priority over the **PCP** command to change the setpoints.

### **PC**

Definition: Setpoint PRESSURE setting. (Factory default is 0.00)

Modifiers: 1 or 2; X.XXE±XX (pressure)

Response: **X.XXE±XX CR** (pressure)

Example: From computer: **PC\_1\_4.35E-02 CR**  
From 375: **4.35E-02 CR**  
or **INVALID** if option not installed

#### NOTE:

If a **PC** command is sent while the setpoints are being changed with the **S.P.** button on the front panel, the command is disregarded and the response is **F\_P\_ERR**. The **S.P.** button has priority over the **PC** command to change the setpoints.

### **RST**

Definition: Reset Controller.

Modifiers: None.

Response: None.

Example: From computer: **RST CR**

#### NOTE:

The RST command will reset the Controller as if the power had been cycled. RST has no response but resets the Controller operation. Communication is re-enabled in 2 seconds.



**HA**

Definition: Enables or disables RTS/CTS handshake.

Modifiers: 1 or 0 (1 enables, 0 disables)

Response: **PROGM\_OK CR**

Example: From computer: **HA1 CR**  
From 375: **PROGM\_OK CR**

**VER**

Definition: Read code version.

Modifiers: None.

Response: Code version number.

Example: From computer: **VER CR**  
From 375: **13627-00 CR**

**CA**

For NIST Traceable System Calibration:

Definition: Calibration status.

Modifiers: None.

Response: **CAL\_VOID CR** — NIST traceable calibration is void. Equivalent to both VAC and ATM LED's being off.

**CAL\_CERT CR** — NIST traceable calibration is valid. Equivalent to both VAC and ATM LED's being lit.

**VC**

For NIST Traceable System Calibration:

Definition: Void calibration.

Modifiers: None.

Response: **PROGM\_OK CR** — Calibration functions are now unlocked. TS, TZ, and FAC commands will now work.

**5.7 Command-Response Timing**

The speed of the response from the 375 Controller varies depending on the type of command being carried out. All commands will cause a response to begin in less than 100 msec. Depending on the selected baud rate, there will be an additional delay as noted in Table 5-8 for the 9 character response from the 375. The response length will vary from 9 characters (see specific command).

**Table 5-8** TX Time of Response.

Baud Rate	TX Response Time T
19,200	4.7 msec data to host
9,600	9.4 msec
4,800	18.7 msec
2,400	37.5 msec
1,200	75 msec

NOTES

## RS-485/422 Computer Interface

### 6.1 RS-485/422 Computer Interface Setup

This option permits data output to, and gauge control by, a host computer. Output control is by a command-response mechanism. If you have this module in your unit, configure it to your system requirements as directed in this chapter.

A variety of baud rates and byte framing options are available

### 6.2 RS-485/422 Computer Interface Factory Default Settings

The following table lists the default settings for the RS-485/422 Computer Interface option. The right hand column lists the section of the manual you can go to for more information about default settings and/or detailed instructions on changing defaults.

**Table 6-1** Guide to Manual Sections for Changing Default Setting.

Feature	Default Setting	Manual Section
RS-485/422 Baud Rate	19.2 kbaud	Section 6.3.1
Byte Format	8 data bits, No parity; 1 stop bit;	Section 6.3.2
RS-485/422 Operation Connection	422 Operation, Address 01 4-Wire mode (485/422)	Section 6.3.4

### 6.3 RS-485/422 Computer Interface Settings

#### 6.3.1 Baud Rate

1. Enter the setup mode by holding the ▲ and ▼ keys down during power-up.
2. Press the **CAL** button so that the Controller display shows **2.05** (or some other number beginning with **2**.) See Table 6-2.
3. Press the ▲ or ▼ keys to select the baud rate. See Table 6-2.

**Table 6-2** Baud Rate Display Readouts.

Display Readout	Baud Rate
<b>2.01</b>	1,200
<b>2.02</b>	2,400
<b>2.03</b>	4,800
<b>2.04</b>	9,600
<b>2.05</b>	<u>19,200</u>

4. Press the **CAL** button to store the value.
5. To select the byte format go to Section 6.3.2 Step 3.  
If you do not need to make any more changes return to operational mode by turning the Controller off and then on again.

### 6.3.2 Selecting the Byte Format

1. Enter the setup mode by holding the ▲ and ▼ keys down during power-up.
2. Press the **CAL** button so that the Controller display shows **3.01** (or some other number beginning with **3**.)
3. Press the ▲ or ▼ keys to select the byte format. See Table 6-3.

**Table 6-3** Byte Format Display Readouts.

Display Readout	Byte Format
<b>3.01</b>	<u>8 data bits, no parity, 1 stop bit</u>
<b>3.02</b>	7 data bits, odd parity, 1 stop bit
<b>3.03</b>	7 data bits, even parity, 1 stop bit

4. Press the **CAL** button to store the value.
5. To select the Address go to Section 6.3.3 Step 3. If you do not need to make any more changes return to operational mode by turning the Controller off and then on again.

### 6.3.3 Selecting an Address

1. Enter the setup mode by holding the ▲ and ▼ keys down during power-up.
2. Press the **CAL** button so that the Controller display shows **4.01** (or some other number beginning with **4**.)
3. Press the ▲ or ▼ keys to select the address. See Table 6-4.

**Table 6-4** Hex Addresses for RS-485/422 Interfaces.

Display Readout	Hex Address
<b>4.01</b>	<u>01 hex</u>
<b>4.0F</b>	0F hex
:	:
<b>4.FF</b>	FF hex

4. Press the **CAL** button to store the value.
5. To select RS-485/422 2-Wire Operation go to Section 6.3.4 Step 3. If you do not need to make any more changes return to operational mode by turning the Controller off and then on again.

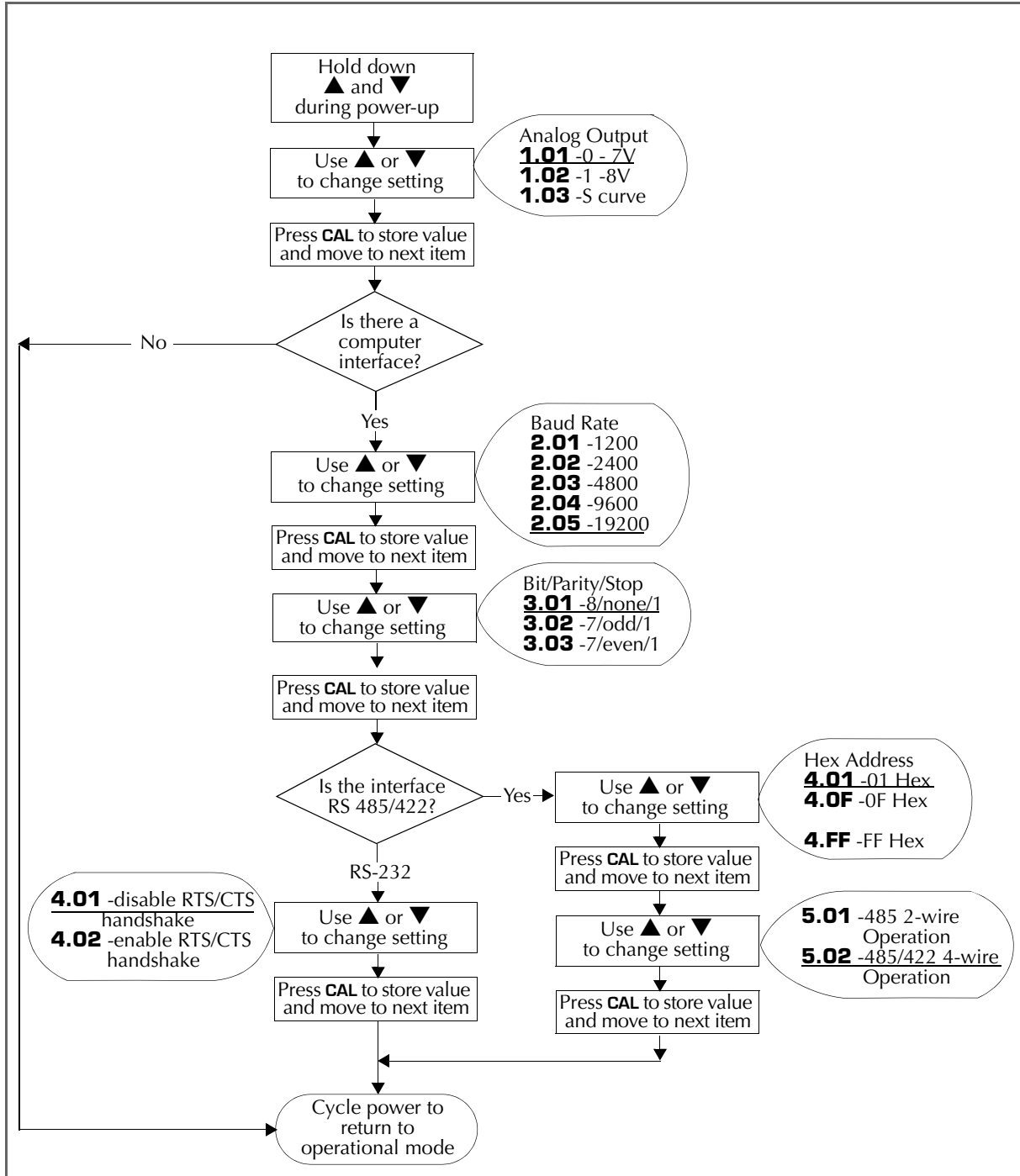
### 6.3.4 Selecting RS-485, RS-422 2- or 4-Wire Operation

1. Enter the setup mode by holding the ▲ and ▼ keys down during power-up.
2. Press the **CAL** button so that the Controller display shows **5.01** or **5.02**.
3. Press the ▲ or ▼ keys to select the RS485/RS-422 2- or 4-wire operation. See Table 6-5.

**Table 6-5** Interface Selection.

Display Readout	Interface
<b>5.01</b>	485 2-Wire Operation
<b>5.02</b>	<u>485/422 4-Wire Operation</u>

4. Press the **CAL** button to store the value.
5. Return to operational mode by turning the Controller off and then on again.



**Figure 6-1** Flow Chart Showing Setup Sequence for RS-485/422 Interface.

### 6.3.5 Handshaking

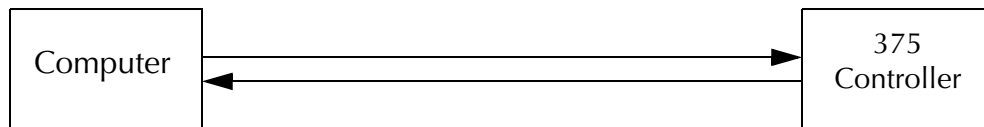
Normal handshake control can be accomplished using the command-response mechanism.

The RS-485 Computer Interface option supports the following balanced transmission line configurations:

- a. RS-422 4-wire (default), separate RX/TX lines
- b. RS-485 2-wire (optional), common RX/TX lines
- c. RS485 4-wire (default), separate RX/TX lines

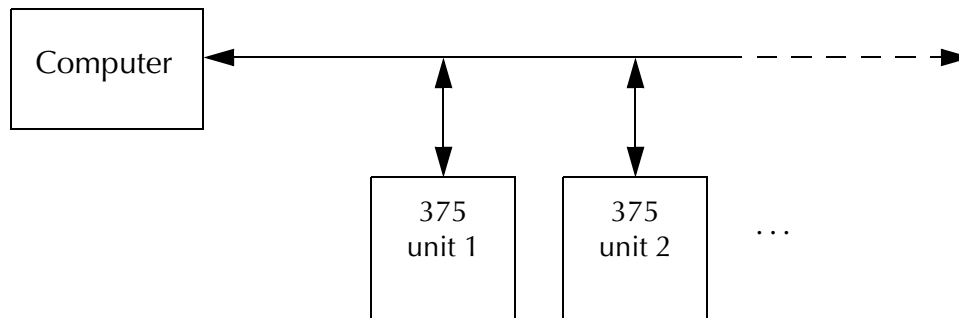
First, some terms need to be defined: *point-to-point*, *multi-drop*, and *multi-point*. For this discussion, a point-to-point configuration is a signal transmitter and single receiver on a twisted pair wire. A multi-drop configuration is a single transmitter and multiple receivers sharing a twisted pair wire. A multi-point configuration has multiple transmitters and one or more receivers sharing a twisted pair wire.

1. RS-422 4-wire (default)



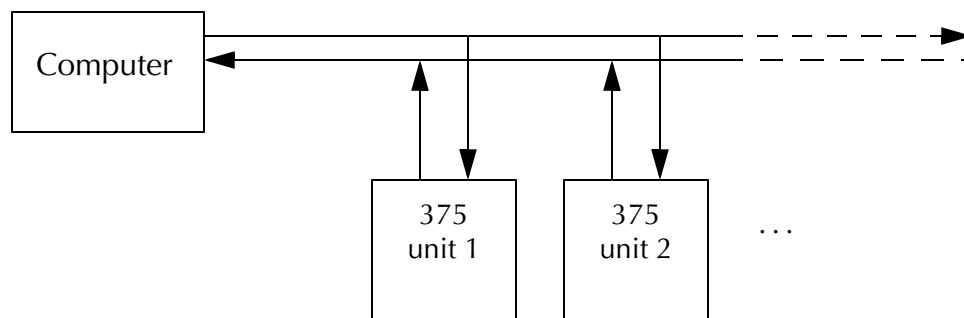
In this example, the 375 Controller is receiving over one pair of wires in a point-to-point configuration and transmitting over a second pair of wires in another point-to-point configuration.

2. RS-485 2-wire (optional)



In this example, multiple 375 Controllers are transmitting and receiving over one pair of wires in a multi-point configuration.

3. RS-485 4-wire (default)



In this example, multiple 375 Controllers are transmitting over one pair of wires in a multi-point configuration and receiving over a second pair of wires in a multi-drop configuration.

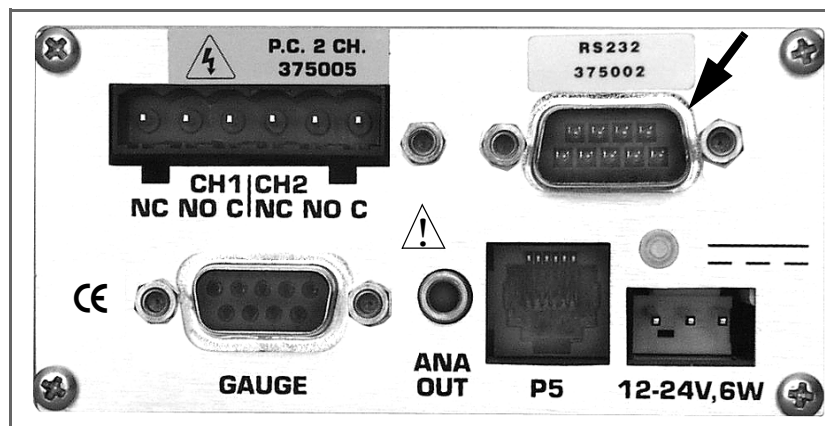
### 6.3.5.1 Line Termination

For best signal quality, transmission line termination resistors should be used. Location of termination resistors depends on the configuration. For point-to-point and multi-drop twisted pair wires, a single termination resistor should be placed in parallel with each receiver input. For multi-point twisted pair wires, two termination resistors should be used — one at each of the farthest ends of the twisted pair cable. For Example 3 in the previous section, termination resistors would be located at the receiving input of each 375 Controller on the multi-drop twisted pair. Two additional termination resistors would be used: one in parallel with the computer transmitter output and other in parallel with the farthest 375 Controller's transmitter output. All termination resistor values should be approximately 120 ohms.

### 6.3.5.2 Communications Protocol

The 375 Controller uses a *command-response half-duplex* protocol. If the 375 Controller recognizes received data as a valid command, it will check the command string address and compare with its own. If the addresses match, the 375 Controller will process the command and then respond. Half-duplex communications are supported. In all configurations, only one twisted pair will have data transmissions in one direction at any time.

## 6.4 Connecting the RS-485/422 Computer Interface



**Figure 6-2** Control Unit Rear Panel Showing RS-485/422 Connector.

Instructions for setting up this interface are in Section 6.1.

This factory or field installed option produces the signals shown in Table 6-6.

A mating 9-pin D type connector is supplied in the hardware kit. Use shielded cable to minimize electromagnetic radiation or susceptibility. Ground the shield to the metal connector shell or to Pin 3.

**Table 6-6** RS-485/422 Connector Pin Assignments, 4-Wire.

Signal	Pin Number	Direction
+ TX	4	To Computer
Ground	3	n.a.
- TX	5	To Computer
+ RX	8	To 375
- RX	9	To 375

**Table 6-7** RS-485/422 Connector Pin Assignments, 2-Wire.

Signal	Pin Number	Direction
Ground	3	n.a.
+ RX and + TX	8	To 375
- RX and - TX	9	To 375

### 6.4.1 Long Cable Operation

Maximum cable length = 4,000 feet. Maximum number of devices = 32.

A common ground wire should be connected to all units for long cable runs.

## 6.5 Preparing for Use of the RS-485/422 Computer Interface

See Section 6.2 and Section 6.3 for connection instructions.

Check the user's manual for the host computer to be sure the protocol used is compatible with that established via the switch configuration in the RS-485/422 module.

Communication with the Control Unit is via ASCII strings. A message consists of a command and a command modifier, followed by a terminator. The message may contain leading spaces, and the command and modifier may optionally be separated by spaces or commas. No spaces may appear within the command or the modifier, only between them.

The terminator expected by the Control Unit is an ASCII carriage-return, denoted here by *CR*. The line-feed is optional, and messages terminated with only the carriage-return will be accepted. Note that the *LF* terminator is sometimes appended automatically by the host computer's interface software to the message string supplied by the user.

If extra characters are found in the message after it has been successfully interpreted but before the terminator has been received, they will be ignored. Characters can be upper- or lower-case. All messages to the 375 will receive a reply, consisting of an ASCII string of upper-case letters terminated with *CR*. Pressures will be returned in the format X.XXE±XX.



## 6.6 RS-485/422 Command Syntax

Command from host must include a start character, address, data and a terminator.

The start character is "#".

The address is two ASCII digits representing the Hex address of the module. This address will also be displayed on the front panel in a hex format. For example: 0F Hex is address 15 Decimal.

The data field is explained in the command descriptions. All alpha characters can be upper or lower case.

All data fields responses will contain 13 upper case alphanumeric characters. A response of **01\_SYNTAX\_ER CR** is caused by an incorrect character string from the host.

### 6.6.1 Command Descriptions

#### RD

Definition: Read Convectron Gauge pressure response.

Modifiers: None.

Response: Pressure Value (\*01\_9.34E-02 CR)

Other possible responses:

**?01\_OPN\_SNSR CR** — Defective transducer

**?01\_SNSR\_UNP CR** — Sensor is unplugged

**?01\_SNSR\_OVP CR** — Pressure higher than 999 Torr, or gasses other than nitrogen in the system. (Atmosphere pressure of helium will cause this response.)

Example: From host: **#01RD CR** (for address of **01**)  
From 375: **\*01\_9.34E-02 CR**

NOTES:

1. \_ = space, CR = carriage return
2. ASCII string representing pressure in scientific notation. Three significant digits except in  $10^{-3}$  Torr range with 2 significant digits and a zero filler,  $10^{-4}$  Torr range with 1 significant digit with 2 zero fillers.
3. While at vacuum, the output should be 0.00E-04 (= 0.0 mTorr displayed.) An output of 0.00E+00 (= -0.0 mTorr displayed) occurs when the transducer voltage at vacuum has drifted lower than that set by the TZ command. The number received at vacuum will fluctuate under normal operation, but if it reads negative consistently, calibration may be required. See Section 3.7 or TZ Command on page 58.

#### SA

Definition: Set address.

Modifiers: Address

Response: **PROGM\_OK**

Example: From computer: **#01\_SA20 CR** (Sets address to 20 hex.)  
From 375: **\*01\_PROGM\_OK CR**

NOTE:

The operating address will not change until the power is cycled or RST is sent. The value displayed and used is a 2 digit ASCII representation of the hex value.

**SC**

Definition: Set communication wiring protocol

Modifiers: 485 or 422

Response: **PROGM\_OK**

Example: From computer: **#01\_SC485 CR**  
From 375: **\*01\_PROGM\_OK CR**

**NOTE:**

Send SC485 for 2-wire RS485 operation, SC422 for 4-wire RS-485/422 operation. Default configuration is RS485/422 4-wire communication. The Controller will continue to operate at the old configuration until power is cycled or RST command is sent.

**TS**

Definition: Set span (typically at atmospheric pressure)

Modifiers: Pressure Value (above 399 Torr)

Response: **PROGM\_OK**

Other possible responses:

**?01\_GAIN\_LIM CR** —Gain programmed at limit. Readout will be the pressure at max TS setting.

**?01\_OPN\_SNSR CR** —Sensor defect, no change in programming. See Maintenance Section 7.4 on page 65.

**?01\_SNSR\_UNP CR** —Sensor unplugged, no change in programming.

**?01\_RANGE-ER CR** —Command error. TS must be set above 399 Torr, and system pressure must be above 399 Torr.

**?01\_INVALID\_CR**—System is calibrated and locked.

Example: From computer: **#01TS 7.60E+02 CR**  
From 375: **\*01\_PROGM\_OK CR**

**NOTE:**

Do this only at pressures above 399 Torr; Controller will respond with range error if done below 399 Torr or near vacuum. The change occurs as soon as the function is performed.

If a **TS** command is sent while the ATM setting is being changed with the **CAL** button on the front panel, the command is disregarded and the response is **?01\_F\_P\_ERR**. The **CAL** button has priority over the **TS** command to set the ATM setting. If the Controller is system-calibrated, the response for this command will be **INVALID\_CR**. See Section 3.7.2.

**TZ**

Definition: Set zero

Modifiers: 0 or pressure below  $1 \times 10^{-1}$  Torr in scientific notation

Response: **PROGM\_OK**

Other possible responses:

**?01\_OFST\_LIM CR** —Offset programmed at limit. Readout will be the pressure at max TZ setting.

**?01\_OPN\_SNSR CR** —Sensor defect. No change in programming. See Maintenance, Section 7.4.

**?01\_SNSR\_UNP CR** —Sensor unplugged. No change in programming.

**?01\_RANGE\_ER CR** —Command error. TZ must be set below  $1 \times 10^{-1}$  Torr, and system pressure must be below  $1 \times 10^{-1}$  Torr.

**?01\_INVALID\_CR**—System is calibrated and locked.

Examples: From computer: **#01TZ0 CR**  
From 375: **\*01\_PROGM\_OK CR**  
From computer: **#01TZ1.00E-02 CR**  
From 375: **\*01\_PROGM\_OK CR**

**NOTES:**

Do this only at pressures below  $1 \times 10^{-1}$  Torr. The response will be an error message if done near atmosphere.

Change occurs as soon as the function is performed

If a **TZ** command is sent while the VAC setting is being changed with the **CAL** button on the front panel, the command is disregarded and the response is **?01\_F\_P\_ERR**. The **CAL** button has priority over the **TZ** command to set the VAC setting. If the Controller is system-calibrated, the response for this command will be **INVALID\_CR**. See Section 3.7.2.

**FAC**

Definition: Set factory default  
Modifiers: None  
Response: **PROGM\_OK CR**  
Example: From computer: **#01FAC CR**  
From 375: **\*01\_PROGM\_OK CR**

**NOTE:**

Cycle power or send RST after doing this function. FAC will cause default VAC and ATM parameters to be programmed as follows:

VAC and ATM values are set to default

If the Controller is system-calibrated, the response for this command will be **INVALID\_CR**. See Section 3.7.2.

**SB**

Definition: Set baud rate  
Modifiers: 1200, 2400, 4800, 9600, 19200  
Response: **PROGM\_OK CR**  
Example: From computer: **#01SB2400 CR**  
From 375: **\*01\_PROGM\_OK CR**

**NOTE:**

Cycle power or send RST after doing this function. The Controller will continue to operate at the old baud rate until power is cycled or RST command is sent. The Maximum baud rate is 19.2 kbaud. The baud rate needs to be set at a valid rate, i.e., 1200, 2400, 4800, 9600, 19200. If the rate is set to an odd value, for example 2234, the Controller will stay at the present rate and respond with **SYNTAX\_ERROR CR**.

### SPN

Definition: Set bits/parity to 8 bits/none, 1 stop bit

Modifiers: None.

Response: **PROGM\_OK CR**

Example: From computer: **#01SPN CR**  
From 375: **\*01\_PROGM\_OK CR**

NOTE:

Cycle power or send RST after doing this function to enable changes.

### SPO

Definition: Set bits/parity to 7 bits/odd, 1 stop bit

Modifiers: None.

Response: **PROGM\_OK CR**

Example: From computer: **#01SPO CR**  
From 375: **\*01\_PROGM\_OK CR**

NOTE:

Cycle power or send RST after doing this function to enable changes.

### SPE

Definition: Set bits/parity to 7 bits/even, 1 stop bit

Modifiers: None.

Response: **PROGM\_OK CR**

Example: From computer: **#01SPE CR**  
From 375: **\*01\_PROGM\_OK CR**

NOTE:

Cycle power or send RST after doing this function to enable changes.

### PCP

Definition: Set the polarity of the relay activation (Factory default is –)

Modifiers: 1 or 2; + or –

Response: **PROGM\_OK CR**

Example: From computer: **#01\_PCP1 +CR**  
From 375: **\*01\_PROGM\_OK CR**  
or **\*01\_INVALID** if option not installed

NOTE:

If a **PCP** command is sent while the setpoints are being changed with the **S.P.** button on the front panel, the command is disregarded and the response is **?01\_F\_P\_ERR**. The **S.P.** button has priority over the **PCP** command to change the setpoints.

**PC**

Definition: Setpoint PRESSURE setting. (Factory default is 0.00)

Modifiers: 1 or 2; x.xxEx±xx (pressure)

Response: **\*01\_X.XXE±XX CR**

Example: From computer: **#01\_PC\_ 4.35E-02**  
From 375: **\*01\_4.35E-02 CR**  
or **INVALID** if option not installed

**NOTE:**

If a **PC** command is sent while the setpoints are being changed with the **S.P.** button on the front panel, the command is disregarded and the response is **?01\_F\_P\_ERR**. The **S.P.** button has priority over the **PC** command to change the setpoints.

**RST**

Definition: Reset module

Modifiers: None.

Response: None.

Example: From computer: **#01RST CR**

**NOTE:**

The RST command will reset the Controller as if the power had been cycled. RST has no response. Communication is re-enabled in 2 seconds.

**VER**

Definition: Read code version

Modifiers: None.

Response: Code version number

Example: From computer: **#01VER CR**  
From 375: **\*01\_13627-00 CR**

**CA**

For NIST Traceable System Calibration:

Definition: Calibration status.

Modifiers: None.

Response: **CAL\_VOID CR** — NIST traceable calibration is void. Equivalent to both VAC and ATM LED's being off.

**CAL\_CERT CR** — NIST traceable calibration is valid. Equivalent to both VAC and ATM LED's being lit.

**VC**

For NIST Traceable System Calibration:

Definition: Void calibration.

Modifiers: None.

Response: **PROGM\_OK CR** — Calibration functions are now unlocked. TS, TZ, and FAC commands will now work.

## 6.7 Command-Response Timing

The speed of the response from the 375 varies depending on the type of command being carried out. All commands will cause a response to begin in less than 100 msec. Depending on the selected baud rate, there will be an additional delay as noted in Table 6-8 for the 13 character response from the 375.

**Table 6-8** RX, TX Time of Response.

Baud Rate	RX and TX Response Time T
19,200	6.8 msec data to host
9,600	13.6 msec
4,800	27 msec
2,400	54.2 msec
1,200	108 msec

## 7.1 Service Guidelines

If a Qualified Service Person makes repairs at the component level, repairs properly made with equivalent electronic parts and rosin core solder do not void the warranty.

If the product requires service, please contact our Customer Service Department at 1-800-776-6543 for troubleshooting help over the phone. Other phone numbers are published at the front of this manual. For Global Customer Support, go to [www.brooks.com](http://www.brooks.com), click on Contact Us, then click on Global Offices to locate the Brooks Automation office nearest you.

If the product must be returned for service, request a Return Authorization (RA) from Brooks Automation / Granville-Phillips. Do not return products without first obtaining an RA. In some cases a hazardous materials document may be required. The Brooks Automation / Granville-Phillips Customer Service Representative will advise you if the hazardous materials document is required.

When returning equipment to Brooks Automation / Granville-Phillips, be sure to package the products to prevent shipping damage. Circuit boards and modules separated from the controller chassis must be handled using proper anti-static protection methods and must be packaged in anti-static packaging. Brooks Automation / Granville-Phillips will supply return packaging materials at no charge upon request. Shipping damage on returned products as a result of inadequate packaging is the Buyer's responsibility.

Because the 375 Controller contains static-sensitive electronic parts, the following precautions must be followed when troubleshooting:

- Use a grounded, conductive work surface. Wear a high impedance ground strap for personal protection.
- Use conductive or static dissipative envelopes to store or ship static sensitive devices or printed circuit boards.
- Do not operate the product with static sensitive devices or other components removed from the product.
- Do not handle static sensitive devices more than absolutely necessary, and only when wearing a ground strap.
- Do not use an ohmmeter for troubleshooting MOS circuits. Rely on voltage measurements.
- Use a grounded, electrostatic discharge safe soldering iron.

*NOTE: This product has been designed and tested to offer reasonably safe service provided it is installed, operated, and serviced in strict accordance with these safety instructions.*



**The service and repair information in this manual is for the use of Qualified Service Personnel. To avoid shock, do not perform any procedures in this manual or perform any servicing on this product unless you are qualified to do so.**

**Do not substitute parts or modify product.**



**Because of the danger of introducing additional hazards, do not install substitute parts or perform any unauthorized modification to the product. Return the product to a service facility designated by Brooks Automation/Granville-Phillips for service and repair to ensure that safety features are maintained. Do not use this product if it has unauthorized modifications.**

## 7.2 Damage Requiring Service

Disconnect this product from the wall outlet and any other power sources, and refer servicing to Qualified Service Personnel if any the following conditions exist:

- The gauge cable, power-supply cord, or plug is damaged.
- Liquid has been spilled onto, or objects have fallen into, the product.
- The product does not operate normally even if you have followed the Operation Instructions. Adjust only those controls that are covered in the instruction manual.
- The product has been dropped or the enclosure has been damaged.



**Replacement Parts - When replacement parts are required, be certain to use the replacement parts that are specified by Brooks Automation/Granville-Phillips, or that have the same characteristics as the original parts. Unauthorized substitutions may result in fire, electric shock or other hazards.**



**Safety Check - Upon completion of any service or repairs to this product, ask the Qualified Service Person to perform safety checks to determine that the product is in safe operating order.**



### 7.3 Symptoms and Possible Causes

**Table 7-1** General Symptoms/Possible Causes.

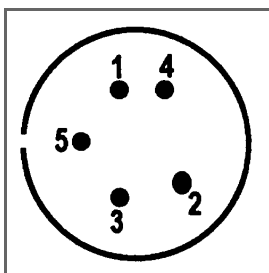
SYMPTOM	POSSIBLE CAUSE
Unit will not power-up, no response to power switch.	PTC tripped. Power interconnect cable improperly connected (see Figure 2-3).
Display indicates - - - " " - - - - " " - 0.0	Unplugged Convectron Gauge Sensor broken in Convectron Gauge. Convectron Gauge zero out of calibration.
Convectron Gauge display reads a fixed (non changing) value.	Controller in VAC, ATM or S.P. Mode.
Pressure reading is higher than expected.	Poor conductance in gauge's vacuum connection to chamber. Gas source in plumbing to gauge, such as leak or contamination. Chamber pressure high because of leak, contamination, or pump failure. Faulty gauge or power cable.
Pressure reading grossly in error.	Controller out of calibration. Unknown gas type. Gauge not mounted horizontally (see Section 2.2). Sensor damaged (e.g., by reactive gas) or dirty. Extremes of temperature or mechanical vibration.

### 7.4 Convectron Gauge Test Procedure

The small diameter sensor wire can be damaged by even small voltages. Do not perform electrical continuity tests with instruments applying in excess of 0.1 volt when the gauge is at vacuum, or 2 volts when at atmospheric pressure.

The Convectron Gauge should show the resistances listed in Table 7-2. Pin numbers are embossed on the gauge base.

If the resistance from pin 1 to 2 is about 800 ohms, the sensor wire is open.



**Figure 7-1** Convectron Gauge Connector.

Pins 1 to 2	21 to 22 ohms
Pins 2 to 3	51 to 52 ohms
Pins 1 to 5	181 to 182 ohms

**Table 7-2** Convectron Gauge Resistances.

## 7.5 Cleaning Contaminated Convector Gauges



**The fumes from solvents such as trichloroethylene, perchloroethylene, toluene, and acetone can be dangerous to health if inhaled. Only use these solvents in well ventilated areas exhausted to the outdoors. Acetone and toluene are highly flammable and should not be used near an open flame or energized electrical equipment.**

The Convector Gauge may be baked to 150 °C nonoperating while under vacuum with the Connector removed.

All materials have been chosen for ultra high vacuum service, corrosion resistance, and bakeability. The envelope is type 304 stainless steel. All metallic joints in the envelope are welded. No solder is used within the envelope. The following materials are exposed to the vacuum: Type 304 stainless steel, Carpenter Alloy 52, Kovar, Kapton, gold plated tungsten, borosilicate glass, and Dow-Corning 9015 glass. The blue trim cover is rated at 150 °C.

When the small sensor wire is contaminated with oil or other films, its emissivity or its diameter may be appreciably altered and a change of calibration will result. Cleaning with trichloroethylene, perchloroethylene, toluene, or acetone is possible but it must be done very carefully so as not to damage the sensor.

Hold the gauge with the main body horizontal and the port projecting upward at an angle of 45 degrees. Slowly fill it with solvent using a standard wash bottle with the spout inserted in the port to the point where it touches the screen. Let the solvent stand in the gauge for at least ten minutes. **Do not shake the gauge.** Shaking the gauge with liquid inside can damage the sensor wire. To drain the gauge, position it horizontally with the port facing downward. Slightly warming the gauge will help dry the gauge. Allow the gauge to dry overnight with the port vertically downward and uncapped. Before re-installing the gauge on the system, be certain no solvent odor remains.

## 7.6 Process Control Troubleshooting

The setpoints are read from non-volatile memory into RAM when the unit powers up.

If a setpoint is found to contain incorrect data which cannot be interpreted as a valid setpoint, it will be set to 0 and polarity set to (-).

## 7.7 RS-232 Troubleshooting

Because the RS-232 “standard” is found in a bewildering array of configurations, the first thing to do if trouble arises is check the following configuration options.

### 1. Check baud/byte.

Be sure baud rate, character format and framing, and interface protocol are matched to the requirements of your host computer or terminal. Note that there may be several mismatched parameters. Check to see if your computer requires the RTS/CTS handshake.

### 2. Check interface wiring.

The pin designations for the RS-232 connector are shown in Table 5-6. Note that the “received” and “transmitted” data lines are defined as seen by the 375 Controller. Many companies supply “null modems” or switch boxes for the purpose of re-configuring the control lines for particular applications. A standard 9 pin extension cable will work for many applications.

3. Check command syntax. Be sure the strings you send to the 375 are in accordance with the syntax defined in Section 5.6.

**Table 7-3** RS-232 Troubleshooting Guide.

SYMPTOM	POSSIBLE CAUSE
No response or garbled output.	Baud rate incorrect. Character length incorrect or stop bit(s) incorrect. Bad cable.
COMM_ERR message.	Parity incorrect.
SYNTAX_ERROR message.	Message to 375 not in accordance with specified syntax. Could also result from failure to assert DCD handshake line.

## 7.8 RS-485/422 Troubleshooting

If your interface fails to function, first verify the following:

1. Baud/byte format.

Verify that the vacuum system controller knows the address of the Series 375. Verify that the communicating computer does not reserve certain addresses for system devices, e.g., a printer.

2. Check interface wiring.

Check the cable to verify that it is good; try swapping in a known good cable.

3. Check command syntax.

Be sure you are following the syntax specified in Section 6.6.

**Table 7-4** IEEE 485/422 Troubleshooting Guide.

SYMPTOM	POSSIBLE CAUSE
SYNTAX_ERROR message.	Message to 375 not in accord with syntax.
COMM_ERR message.	Parity incorrect.
No response.	Incorrect address setting. Bad cable.

### 7.8.1 Field Installation of Options

1. Turn off power.
2. With power off, remove any cables from the Controller rear panel.
3. Observe antistatic precautions to avoid damaging static sensitive components inside the chassis. Use a grounded, conductive work surface. Do not handle MOS devices more than absolutely necessary, and only when wearing a high impedance ground strap. Use conductive envelopes to store or ship MOS devices or printed circuit boards. Do not operate the 375 Controller with MOS devices removed from the printed circuit boards.
4. After placing the Controller on the bench, remove the four rear corner screws that hold the rear plate to the Controller.
5. Slide the rear plate and printed circuit boards out of the rear of the Controller.
6. Locate correct position for module.
7. Install the module in its proper position, making sure front pins align, and rear connector fits in the opening.
8. Install hardware to fasten option board to the rear panel.
9. Install the boards into the controller making sure of proper slot alignment and shield alignment.
10. Replace the four rear panel screws.
11. Apply option labeling to the rear of the Controller

### 7.9 Factory Default Settings

Follow the procedure below to return the 375 to its factory default settings:

1. Hold down both ▲ and ▼ while powering on.
2. Use ▲ or ▼ to set the display indication to **1.01** (0 – 7 V analog output.)
3. Press **CAL**.
4. Use ▲ or ▼ to set the display indication to **2.05** (19.2 kbaud.)
5. Press **CAL**.
6. Use ▲ or ▼ to set the display indication to **3.01** (8/none/1.)
7. Press **CAL**.
8. Use ▲ or ▼ to set the display indication to **4.01** (01 address or RTS disabled.)
9. Press **CAL**.
10. Use ▲ or ▼ to set the display indication to **5.02** (RSS-422 4-wire operation.)
11. Press **CAL**.
12. Cycle power to restore operation.

The process control settings are 0.0 and can be changed from the front panel. See Chapter 4.

## A

- address selection
  - RS-485/422 **52**
- analog output signal
  - nonlinear **33**
- atmospheric pressure indications, adjusting **30**

## B

- baud rate
  - RS-232 **39**
  - RS-485/422 **51**
- byte format
  - RS-232 **40**
  - RS-485/422 **52**

## C

- calibration **30**
- certification, product **10**
- cleaning contaminated gauges **65**
- command descriptions
  - RS-232 **45**
  - RS-485/422 **57**
- command syntax
  - RS-232 **45**
  - RS-485/422 **57**
- components **11**
- computer interface setup
  - RS-232 **39**
  - RS-485/422 **51**
- Controller
  - installation **15**
  - switch overview **20**
- Convectron Gauge **19**
  - atmospheric pressure indications, adjusting **30**
  - cleaning contaminated gauges **65**
  - gas type, selecting **20**
  - gauge operation, preparing for **20**
  - mounting gauges **13**
    - 1/8 NPT mount **15**
    - compression mount/quick connect **14**
    - ConFlat flange mount **15**
    - NW16KF flange mount **15**
    - VCR/VCO mount **15**
  - pressure measurement
    - other than nitrogen **21**
    - preparing for **19**
  - special considerations for use below 10-3 Torr **31**
  - zero adjustment **30**

## D

- damage requiring service **64**
  - safety **8**
- default settings
  - Process Control **35**
  - return to **68**
  - RS-232 **39**
  - RS-485/422 **51**

## E

- examples **23**

## F

- field installation of options **67**

## G

- gas type, selecting **20**
- ground test **9**

## H

- handshaking
  - RS-232 **40**
  - RS-485/422 **54**

## I

- installation
  - Controller **15**
  - Convectron Gauge **13**

## L

- lockout switch **20**
- long cable operation
  - RS-485/422 **56**

## M

- mounting gauges
  - Convectron Gauge **13**
    - 1/8 NPT mount **15**
    - compression mount/quick connect **14**
    - ConFlat flange mount **15**
    - NW16KF flange mount **15**
    - VCR/VCO mount **15**

## N

- NIST traceable system calibration **31**
  - RS-232 **49**
  - RS-485/422 **61**
  - nonlinear analog output **33**

## O

- options
  - field installation **67**
  - RS-232 computer interface **39**
  - RS-485/422 computer interface **51**

## P

- pawl screw **16**
- power supply **16**
- pre-installation considerations **13**
- pressure measurement
  - examples **23**
  - gases other than nitrogen **21**
  - preparing for **19**
- Process Control
  - connecting relays **36**
  - factory default settings **35**
  - setpoint display and adjustment **37**
  - setup procedure **35**
  - tips **37**
  - troubleshooting **66**

## R

- response timing
  - RS-232 **49**
  - RS-485/422 **62**
- RS-232
  - byte format **40**
  - command descriptions **45**
    - CA **49**
    - FAC **47**
    - HA **49**
    - PC **48**
    - PCP **48**
    - RD **45**
    - RST **48**
    - SB **47**
    - SPE **48**
    - SPN **47**
    - SPO **47**
    - TS **45**
    - TZ **46**
    - VC **49**
    - VER **49**
  - command syntax **45**
  - computer interface setup **39**
  - connecting **42**
  - factory default settings **39**
  - handshaking **40**
  - pin assignments **43**
  - preparing to use **44**
  - response timing **49**
  - RTS/CTS **40**
  - troubleshooting **66**

RS-485/422  
address selection **52**  
baud rate **51**  
byte format **52**  
command descriptions **57**  
    CA **61**  
    FAC **59**  
    PC **61**  
    PCP **60**  
    RD **57**  
    RST **61**  
    SA **57**  
    SB **59**  
    SC **58**  
    SPE **60**  
    SPN **60**  
    SPO **60**  
    TS **58**  
    TZ **58**  
    VC **61**  
command syntax **57**  
communications protocol **55**  
computer interface setup **51**  
connecting **55**  
factory default settings **51**  
handshaking **54**  
line termination **55**  
long cable operation **56**  
preparing to use **56**  
response timing **62**  
selecting RS-485 or RS-422  
    operation **52**  
troubleshooting **67**

## **S**

safety  
    damage requiring service **8**  
    instructions **7**  
selecting RS-485 or RS-422 operation  
    RS-485/422 **52**  
service  
    damage requiring **64**  
    guidelines **10, 63**  
system components **11**  
system ground **9**

## **T**

troubleshooting  
    Process Control **66**  
    RS-232 **66**  
    RS-485/422 **67**  
    symptoms and possible causes **64**

## **W**

warranty **10**

## **Z**

zero adjustment **30**



## Series 375

# Granville-Phillips® Series 375 Convectron® Vacuum Gauge Controller



**6450 Dry Creek Parkway**  
Longmont, CO 80503 USA  
Phone: 1-303-652-4400

**15 Elizabeth Drive**  
Chelmsford, MA 01824 USA  
Phone: 1-978-262-2400

Worldwide Customer Service/Support - 24/7  
Phone: 1-800-367-4887

To obtain a copy of this instruction manual online,  
visit our website at [www.brooks.com](http://www.brooks.com)  
(Adobe® Reader® version 5.0 or higher required)

© 1999-2008 Brooks Automation, Inc.

## Instruction Manual

*Instruction manual part number 375015*

*Revision 05 - April 2008*